

SOLID CONSTRUCTION BUT IN WOOD

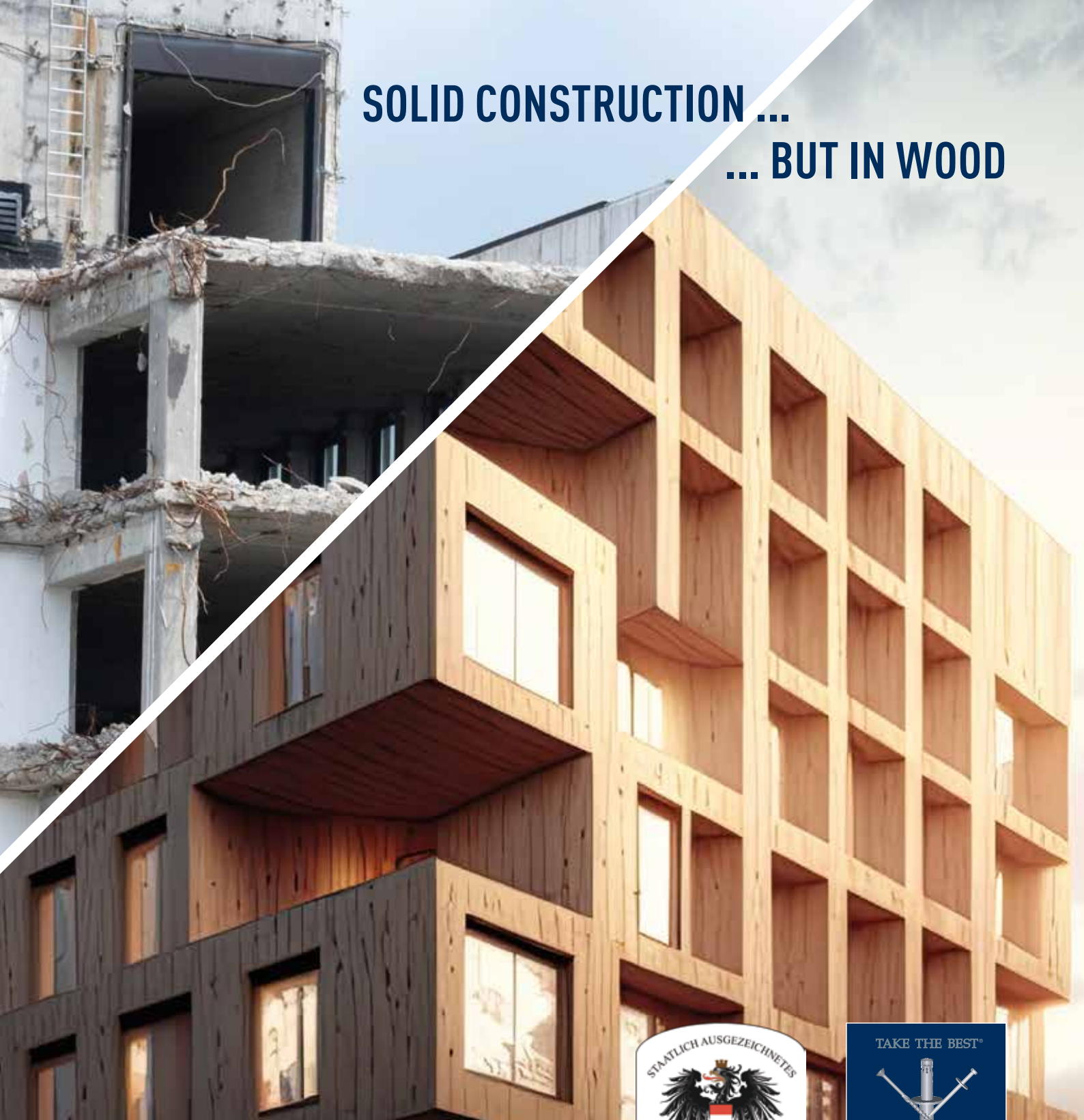

MASS-X[®] CLT RANGE (Technical data)



**KLIMANEUTRALES
UNTERNEHMEN**
certified by Fokus Zukunft
Klimaneutral durch Kompensation
mit Klimaschutzzertifikaten



PRODUCTFINDER

✓ Usable

✗ Not Usable

– Not Relevant

	Threshold timber	Wall-to-concrete	Wall-to-wall	Ceiling joist	Wall-to-ceiling
Wood connectors					
Mass-X® Angle Z	✗	✗	✓	✗	✓
Mass-X® EZ					
Mass-X® Angle Q	✗	✓	✗	✗	✓
Mass-X® Angle Q HB	✓	✓	✗	✗	✗
Mass-X® Angle Q HH	✓	✗	✗	✗	✗
Mass-X® Shear	✗	✗	✓	✗	✗
Mass-X® Pull Angle P-HB 340	✓	✓	✗	✗	✗
Mass-X® Pull HB 60 / 70	✓	✓	✗	✗	✗
Mass-X® Pull HH 60 / 70	✗	✗	✓	✗	✓
IdeFix® DWD	✗	✗	✓	✗	✓
HobaFix® HF / HobaFix® Max HFM	✗	✗	✗	✓	✗
Structural fasteners					
BeziFix® Anchor ZSS	✓	✓	✗	✗	✗
GoFix® X+, S+	✗	✗	✓	✓	✓
Angled fitting screw	✓	✓	✗	✗	✓
GoFix® MS II	✗	✗	✓	✓	✓
GoFix® ZSS	✓	✗	✗	✗	✓
Anchor nail	✓	✓	✓	✗	✓
Other products					
Pick family	✗	✗	✗	✗	✗
IdeFix® IF/IFD	✗	✗	✓	✓	✓
Monitorix®					system f
WabaFix® WF	✗	✓	✓	✓	✓
HobaFix® HFM	✗	✗	✓	✗	✗
Mass-X® Calm 1,2,3	✓	✓	✓	✓	✓
Mass-X® Decoupling profile	✓	✓	✓	✓	✓
Mass-X® Angle decoupling	✓	✓	✗	✗	✓



Ceiling-to-ceiling	Wall-to-floor	Roof	Stairs	Insulation	Handling	
X	✓	-	-	-	-	
X	✓	-	-	-	-	
X	✓	-	-	-	-	
X	✓	-	-	-	-	
✓	X	-	-	-	-	
X	✓	-	-	-	-	
X	✓	-	-	-	-	
X	✓	-	-	-	-	
✓	✓	-	-	-	-	
X	X	✓	✓	-	-	
X	✓	X	X	X	-	
✓	✓	✓	✓	X	-	
✓	✓	X	X	X	-	
✓	✓	✓	✓	✓	-	
X	✓	X	X	X	-	
X	✓	X	X	X	-	
X	X	X	X	X	✓	
X	X	✓	✓	X	-	
For structural monitoring						
X	✓	✓	✓	-	-	
X	X	X	X	X	X	
X	✓	✓	✓	X	-	
X	✓	X	✓	X	-	
X	✓	X	-	-	-	

MASS-X[®] ANGLE Z

Connector developed for modern timber construction

The Mass-X[®] Angle Z is ideally suited for **use in solid wood construction**. Its field of application is limited to the use of CLT (cross-laminated timber). Due to its solid design, it can **transmit high forces**. In contrast to the standard angles, the Mass-X[®] Angle Z can be combined with our IdeFix[®] IF. This makes it possible to construct complex connections.

Advantages

- High load capacity
- Variable applications
- Mass-X[®] Angle decoupling Z

Instructions for use

For the Mass-X[®] Angle Z, the Angle fitting screw 5 x (50, 60, 70 mm) is used in combination with the GoFix[®] S+ 10 x 125 mm. When used with IdeFix[®] IF, only 4 IdeFix[®] IF and 4 GoFix[®] S+ are required. (See application picture) A combination of IdeFix[®] IF and screw bolts through a wall is also possible. The load values of the ETA must be observed.



SIHGA [®] montagepack	Dimension			Material	Material thickness [mm]
	Length	Width	Height		
Art. No.	PU	[mm]			
60736	10	230	80	120	S250 galvanised 4



To match:

Mass-X[®] Angle decoupling Z
(Art. No.: 60946)

More information can be found
on page 95

ETA-23/0353

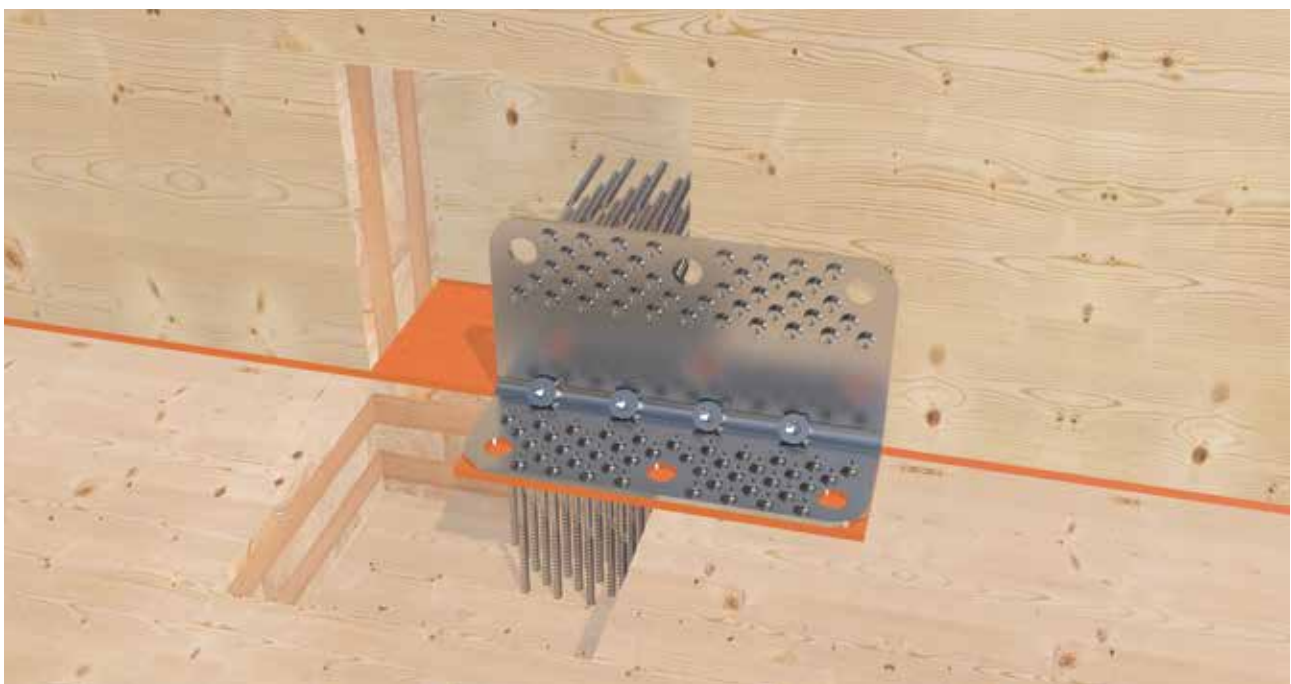

Mass-X[®] Angle Z for fixing a wall to the wooden floor of the upper storey.

MASS-X[®] ANGLE Z

Static values

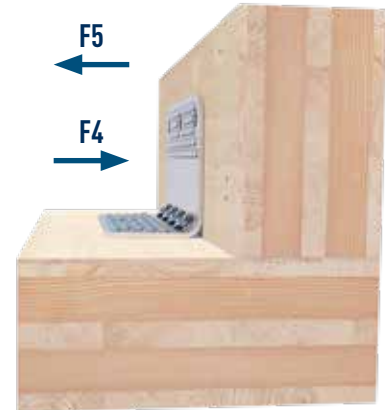
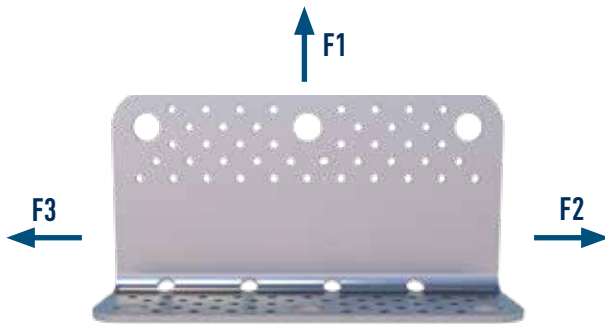

Displacement module

$K_{1,ser}$	$K_{2/3,ser}$	$K_{4,ser}$	$K_{5,ser}$
$F_{1,Rk} / 6 \text{ mm}$	$F_{2/3,Rk} / 2 \text{ mm}$	$F_{4,Rk} / 2,5 \text{ mm}$	$F_{5,Rk} / 2,5 \text{ mm}$

Load direction F1; F2/F3; F4; F5

Vertical leg connection WBS Ø 5 mm n=43	5,0 x 50	5,0 x 60	5,0 x 70	5,0 x 50	5,0 x 60	5,0 x 70	5,0 x 50	5,0 x 60	5,0 x 70
Horizontal leg connection	WBS 5,0 x 50 n=43	WBS 5,0 x 60 n=43	WBS 5,0 x 70 n=43	IdeFix [®] IF Ø 40 n=3	IdeFix [®] IF Ø 40 n=3	IdeFix [®] IF Ø 40 n=3	M16 8.8 n=3	M16 8.8 n=3	M16 8.8 n=3
GoFix [®] S+ 10 x 125 n=4									
$F_{1,Rk}$ tension	62,4 kN	69,1 kN	75,7 kN	43,1 kN	43,1 kN	43,1 kN	43,1 kN	43,1 kN	43,1 kN
$F_{2/3,Rk}$	58,3 kN	62,1 kN	66,0 kN	55,9 kN	55,9 kN	55,9 kN	58,3 kN	62,1 kN	66,0 kN 60,5 kN
$F_{4,Rk}$	54 kN						54 kN		
$F_{5,Rk}$ tension ⊥ on CLT	6,9 kN	6,9 kN	6,9 kN	6,9 kN	6,9 kN	6,9 kN	6,9 kN	6,9 kN	6,9 kN

Load direction F1; F2/F3; F4; F5

Vertical leg connection	IdeFix [®] IF Ø 40 n=3			IdeFix [®] IF Ø 40 n=2			M16 8.8 n=3			M16 8.8 n=2		
GoFix [®] S+ 10 x 125 n=4												
Horizontal leg connection	WBS Ø 5,0 n=43	IdeFix [®] IF Ø 40 n=3	M16 8.8 n=3	WBS Ø 5,0 n=43	IdeFix [®] IF Ø 40 n=3	M16 8.8 n=2	WBS Ø 5,0 n=43	IdeFix [®] IF Ø 40 n=3	M16 8.8 n=3	WBS Ø 5,0 n=43	IdeFix [®] IF Ø 40 n=3	M16 8.8 n=3
$F_{1,Rk}$ tension	43,1 kN			29,9 kN			43,1 kN			43,1 kN		
$F_{2/3,Rk}$	26,0 kN			22,3 kN			34,4 kN 29,3 kN			29,6 kN 25,2 kN		
$F_{4,Rk}$	54,0 kN			54,0 kN			54,0 kN			54,0 kN		
$F_{5,Rk}$ tension ⊥ on CLT	4,8 kN			4,8 kN			4,8 kN			4,8 kN		

$F_{4,Rk}$ =54 kN pressure ⊥ on CLT; independent of connections.

For connections with M16 8.8 if bolt head or nut is not located on CLT: Washer with $d_s=40\text{mm}$.

$\rho_s=350 \text{ kg/m}^3$ conservative for some approved cross-laminated timber, increase of load bearing capacities according to ETA-23/0353 with $k_{dens}=\left(\frac{\rho_s}{350 \text{ kg/m}^3}\right)^{0,5}$.

Twisting of the cross-laminated timber components must be prevented by the design of the supporting structure.

When connecting on both sides with Mass-X[®] Angle Z, the values in this table may be used for each of the two angles. Only for the connection with M16 screws do the values for $F_{2/3,Rk}$ - change. In other words, if Mass-X[®] Angle Z are applied to the top and bottom of the ceiling, the values printed in bold must be used.

MASS-X[®] ANGLE Z

Example combinations

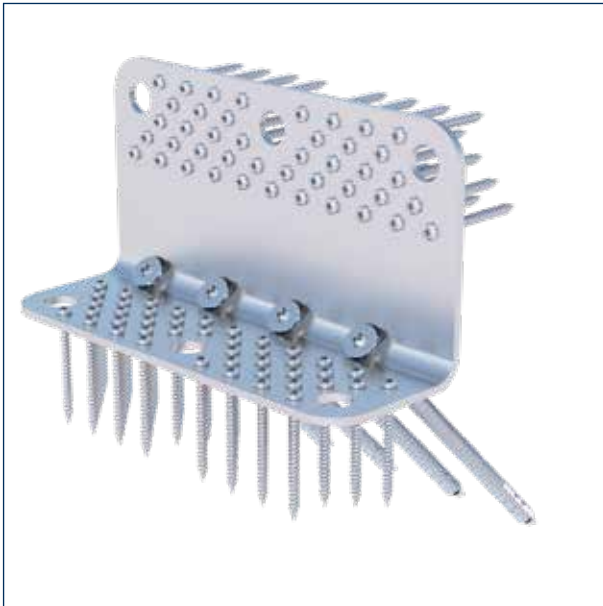

GoFix[®] S+ + Angle fitting screw 5 x 60 mm

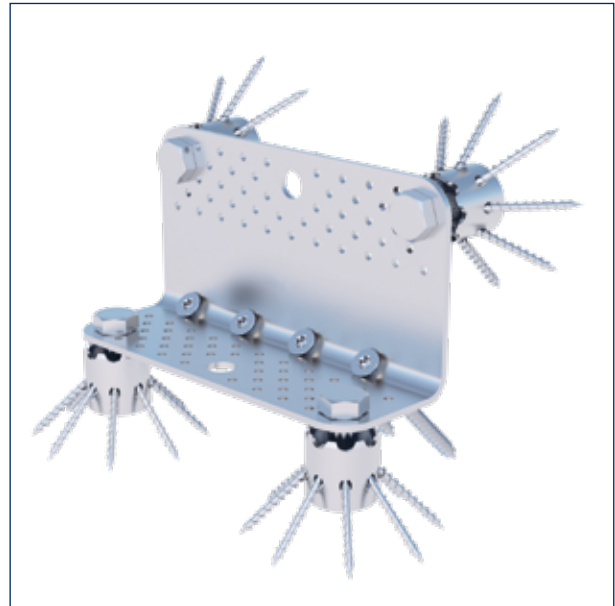

GoFix[®] S+ + IdeFix[®] IF



GoFix[®] S+ + Angle fitting screw + IdeFix[®] IF



Connected to each other by means of M16 hexagon head screws

MASS-X[®] EZ

The „Elementzug“ -
indispensable for modern timber construction

Advantages

- Fastening possible in any position
- Mass-X[®] EZ leaves only minimal processing marks
- Fast, simple and material-friendly fastening
- With rotatable 360° plate



MADE IN AUSTRIA

SIHGA [®] montagepack		Length	Dimension plate	
Art. No.	PU		Width [mm]	Height
60926	1	160	60	8



Mass-X[®] EZ application.

MASS-X[®] ANGLE Q

Connectors developed for modern timber construction to absorb shear forces

Advantages

- Many different areas of application
- For mounting in wood and concrete
- Very high shear carrying capacity thanks to new fastening concept
- Fewer connectors required
- When anchoring to the concrete component, the Mass-X[®] Angle Q must be supplemented with the Mass-X[®] Angle Q base plate 230 x 68 (Art. No.: 60716)

Instructions for use

or anchoring in wood, there are 6 angled screw holes per leg and 41 holes which are optionally provided for angle fitting screws (WBS) or anchor nails. Depending on the application, we have provided two additional partial utilisations of the fixing holes, which are also available as a type static calculation. Anchoring in concrete is done through the holes provided for this purpose (Ø 14 mm) using our BeziFix[®] Anchor ZSS Ø 12.5 x 120 mm.

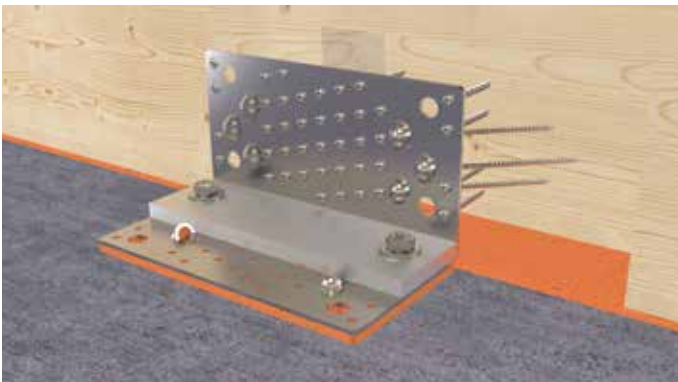

Mass-X[®] Angle Q for fixing a wall to the concrete foundation.

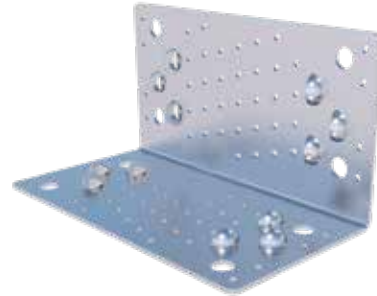

SIHGA [®] montagepack	PU	Dimension		Material	Material thickness
		Length	Width		
Art. No.		[mm]			[mm]
60706	10	230	120	S250 galvanised	3

To match:

BeziFix[®] Anchor ZSS Ø 12,5 x 120 mm, Angle fitting screw, GoFix[®] ZSS, Anchor nail, Mass-X[®] Angle Q Base plate 230 x 68, Mass-X[®] Angle decoupling Q



To match:

Mass-X[®] Angle decoupling Q (Art. No.: 60726)
More information can be found on page 95

ETA-23/0353



MASS-X[®] ANGLE Q BASE PLATE 230 X 68



SIHGA [®] montagepack	PU	Dimension		Material	Material thickness
		Length	Width		
Art. No.		[mm]			[mm]
60716	5	230	68	S235 galvanised	12

MASS-X[®] ANGLE Q

Static values Full utilisation



Load direction F2/F3

Wood-to-wood connection					
Vertical leg connection	Anchor nail Ø 4 x 40 n=41	Anchor nail Ø 4 x 50 n=41	Anchor nail Ø 4 x 60 n=41	WBS Ø 5 x 50 n=41	WBS Ø 5 x 60 n=41
	GoFix [®] ZSS Ø 5 x 120 n=6				
Horizontal leg connection	Anchor nail Ø 4 x 40 n=41	Anchor nail Ø 4 x 50 n=41	Anchor nail Ø 4 x 60 n=41	WBS Ø 5 x 50 n=41	WBS Ø 5 x 60 n=41
	GoFix [®] ZSS Ø 5 x 120 n=6				
Char. shear capacity [kN]	37,3	44,3	47,9	44,6	47,6
Char. shear capacity [kN] (use Mass-X [®] Angle decoupling Q)	28,9	34,4	37,4	34,8	37,1

The load-bearing capacities were determined on the basis of ETA-23/0353. Characteristic load-bearing capacity in kN, wood strength class 350 kg/m³ char. bulk density. The minimum connecting material edge distances according to EC 5 must be observed.

Load direction F2/F3

Wood-to-concrete connection					
Vertical leg connection	Anchor nail Ø 4 x 40 n=41	Anchor nail Ø 4 x 50 n=41	Anchor nail Ø 4 x 60 n=41	Angle fitting screw Ø 5 x 50 n=41	Angle fitting screw Ø 5 x 60 n=41
	GoFix [®] ZSS Ø 5 x 120 n=6				
Horizontal leg connection	BeziFix [®] Anchor ZSS Ø 12,5 x 120 n=2 incl. Mass-X [®] Angle Q Base plate 230 x 68				
Char. shear capacity [kN] wood	37,3	44,3	47,9	44,6	47,6
Design value shear capacity[kN] concrete	36,2				
Design value shear capacity [kN] (use Mass-X [®] Angle decoupling Q)	32,6				

The load-bearing capacities were determined on the basis of ETA-23/0353. Characteristic load-bearing capacity in kN, wood strength class 350 kg/m³ char. bulk density. The minimum connecting material edge distances according to EC 5 must be observed. The design values of the BeziFix[®] ZSS anchors were determined on the basis of ETA-16/0889 and EN 1992-4.

Edge parameters for design values on concrete: see page 11.

Caution: Check the assumptions made. The specified values, type and number of connecting materials represent a pre-dimensioning. Projects must be dimensioned exclusively by authorised persons in accordance with the State Building Code. For definitive proof of stability, please contact a structural engineer qualified according to the State Building Code (LBauO).

MASS-X[®] ANGLE Q

Partial utilisation 1



Load direction F2/F3

Wood-to-wood connection					
Vertical leg connection	Anchor nail Ø 4 x 40 n=34	Anchor nail Ø 4 x 50 n=34	Anchor nail Ø 4 x 60 n=34	WBS Ø 5 x 50 n=34	WBS Ø5x60 n=34
	GoFix [®] ZSS Ø 5 x 120 n=6				
Horizontal leg connection	Anchor nail Ø 4 x 40 n=34	Anchor nail Ø 4 x 50 n=34	Anchor nail Ø 4 x 60 n=34	WBS Ø 5 x 50 n=34	WBS Ø 5 x 60 n=34
	GoFix [®] ZSS Ø 5 x 120 n=6				
Char. shear capacity [kN]	29,1	34,6	37,4	34,9	37,2
Char. shear capacity [kN] (use Mass-X [®] Angle decoupling Q)	22,6	26,9	29,4	27,2	29

Load direction F2/F3

Wood-to-concrete connection					
Vertical leg connection	Anchor nail Ø 4 x 40 n=34	Anchor nail Ø 4 x 50 n=34	Anchor nail Ø 4 x 60 n=34	Angle fitting screw Ø 5 x 50 n=34	Angle fitting screw Ø 5 x 60 n=34
	GoFix [®] ZSS Ø 5 x 120 n=6				
Horizontal leg connection	BeziFix [®] Anchor ZSS Ø 12,5 x 120 n=2 incl. Mass-X [®] Angle Q Base plate 230 x 68				
Char. shear capacity [kN] wood	29,1	34,6	37,4	34,9	37,2
Design value shear capacity [kN] concrete	36,2				
Design value shear capacity [kN] (use Mass-X [®] Angle decoupling Q)	32,6				

The load-bearing capacities were determined on the basis of ETA-23/0353. Characteristic load-bearing capacity in kN, wood strength class 350 kg/m³ char. bulk density.

The minimum connecting material edge distances according to EC 5 must be observed. The design values of the BeziFix[®] ZSS anchors were determined on the basis of ETA-16/0889 and EN 1992-4.

Edge parameters for design values on concrete: see page 11.

Caution: Check the assumptions made. The specified values, type and number of connecting materials represent a pre-dimensioning. Projects must be dimensioned exclusively by authorised persons in accordance with the State Building Code. For definitive proof of stability, please contact a structural engineer qualified according to the State Building Code (LBauD).

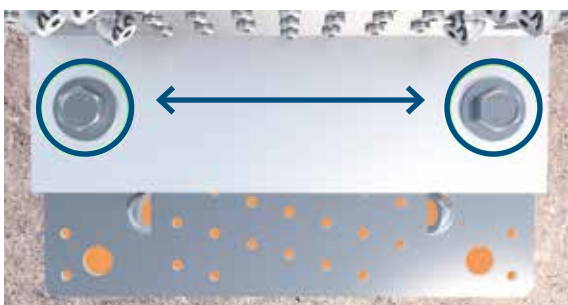

Notice

All values given refer to the drilling pattern shown. We recommend using this as it has a considerably higher shear carrying capacity compared to the rear holes.



MASS-X[®] ANGLE Q

Partial utilisation 2

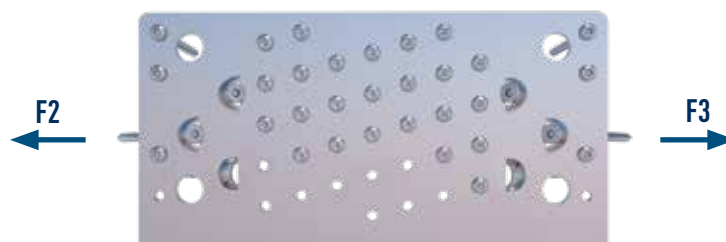

Load direction F2/F3

Wood-to-wood connection

	Anchor nail Ø 4 x 40 n=29	Anchor nail Ø 4 x 50 n=29	Anchor nail Ø 4 x 60 n=29	WBS Ø 5 x 50 n=29	WBS Ø 5 x 60 n=29
Vertical leg connection	GoFix [®] ZSS Ø 5 x 120 n=4				
Horizontal leg connection	Anchor nail Ø 4 x 40 n=29	Anchor nail Ø 4 x 50 n=29	Anchor nail Ø 4 x 60 n=29	WBS Ø 5 x 50 n=29	WBS Ø 5 x 60 n=29
Char. shear capacity [kN]	23,6	28,0	30,4	28,3	30,1
Char. shear capacity [kN] (use Mass-X [®] Angle decoupling Q)	18,3	21,8	23,9	22,1	23,5

Load direction F2/F3

Wood-to-concrete connection

	Anchor nail Ø 4 x 40 n=29	Anchor nail Ø 4 x 50 n=29	Anchor nail Ø 4 x 60 n=29	Angle fitting screw Ø 5 x 40 n=29	Angle fitting screw Ø 5 x 50 n=29	Angle fitting screw Ø 5 x 60 n=29
Vertical leg connection	GoFix [®] ZSS Ø 5 x 120 n=4					
Horizontal leg connection	BeziFix [®] Anchor ZSS Ø 12,5 x 120 n=2 incl. Mass-X [®] Angle Q Base plate 230 x 68					
Char. shear capacity [kN] wood	23,6	28,0	30,4	26,5	28,3	30,1
Design value shear capacity [kN] concrete	36,2					
Design value shear capacity [kN] (use Mass-X [®] Angle decoupling Q)	32,6					

The load-bearing capacities were determined on the basis of ETA-23/0353. Characteristic load-bearing capacity in kN, wood strength class 350 kg/m³ char. bulk density.

The minimum connecting material edge distances according to EC 5 must be observed. The design values of the BeziFix[®] ZSS anchors were determined on the basis of ETA-16/0889 and EN 1992-4.

Edge parameters for design values on concrete: see page 11.

Caution: Check the assumptions made. The specified values, type and number of connecting materials represent a pre-dimensioning. Projects must be dimensioned exclusively by authorised persons in accordance with the State Building Code. For definitive proof of stability, please contact a structural engineer qualified according to the State Building Code (LBauO).

MASS-X[®] ANGLE Q HB / HH

Mass-X[®] Angle Q HB

The Mass-X[®] Angle Q HB (wood / concrete) is an angle connector specially developed for modern timber construction to **absorb shear forces**. Thanks to its low height, it is ideally suited for use in **timber frame construction**. Through the Mass-X[®] Angle Q HB base plate 230 x 48, the occurring **loads** can be **optimally** transferred into the concrete.

Advantages

- For mounting on concrete
- Very high shear carrying capacity thanks to new fastening concept
- Fewer connectors required
- May only be used in combination with the Mass-X[®] Angle Q HB base plate 230 x 48 (Art. No.: 60966)



Mass-X[®] Angle Q HB with Mass-X[®] Angle Q HB base plate 230 x 48 for fixing a wall to the concrete foundation.



SIHGA [®] montagepack	Dimension Length Width Height	Material	Material thickness
60756	10 230 100 70	S250 galvanised	3
Mass-X[®] Angle Q HB Base plate 230 x 48			
60966	5 230 48	S235 galvanised	12



To match:

Mass-X[®] Angle decoupling Q HB (Art. No.: 60956)

More information can be found on page 95

ETA-23/0353



Mass-X[®] Angle Q HH

The Mass-X[®] Angle Q HH (wood / wood) is an angle connector specially developed for modern timber construction to **absorb shear forces**. Thanks to its low height, it is ideally suited for use in **timber frame construction**.

Advantages

- For mounting on wood
- Very high shear carrying capacity thanks to new fastening concept
- Fewer connectors required
- In combination with the GoFix[®] S+, particularly high tensile forces can be absorbed



Mass-X[®] Angle Q HH for fastening a wall to the wooden floor of the upper storey.



SIHGA [®] montagepack	Dimension Length Width	Material	Material thickness
60746	10 230 70	S250 galvanised	3



To match:

Mass-X[®] Angle decoupling Q HH (Art. No.: 60936)

More information can be found on page 95

ETA-23/0353



MASS-X[®] ANGLE Q HB / HH

Mass-X[®] Angle Q HB - Static values

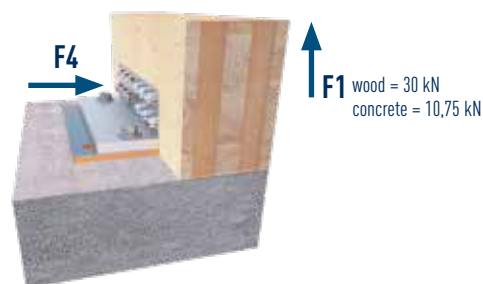

Load direction F2/F3/F4

Wood-to-concrete connection

Vertical leg connection	Angle fitting screw Ø 5 x 50 n=3 GoFix [®] ZSS Ø 5 x 120 n=12
Horizontal leg connection	BeziFix [®] Anchor ZSS Ø 12,5 x 120 n=2 incl. Mass-X [®] Angle Q HB Base plate 230 x 48
Char. shear capacity $F_{2/3}$ [kN] wood	40,0
Char. shear capacity F_x [kN] wood	40,0
Design value shear capacity $F_{2/3}$ [kN] concrete	36,2
Design value shear capacity $F_{2/3}$ [kN] (use Mass-X [®] Angle decoupling Q HB)	33,4
Design value load-bearing capacity F_x [kN] concrete	32,8
Design value shear capacity F_x [kN] (use Mass-X [®] Angle decoupling Q HB)	25,7

The load-bearing capacities were determined on the basis of ETA-23/0353. Characteristic load-bearing capacity in kN, wood strength class 350 kg/m³ char. bulk density.

The minimum connecting material edge distances according to EC 5 must be observed. The design values of the BeziFix[®] ZSS anchors were determined on the basis of ETA-16/0889 and EN 1992-4.

When used in timber frame construction, minimum threshold height 80 mm. **Edge parameters for design values on concrete: see page 11.**

Caution: Check the assumptions made. The specified values, type and number of connecting materials represent a pre-dimensioning. Projects must be dimensioned exclusively by authorised persons in accordance with the State Building Code. For definitive proof of stability, please contact a structural engineer qualified according to the State Building Code (LBau0).

Mass-X[®] Angle Q HH - Static values

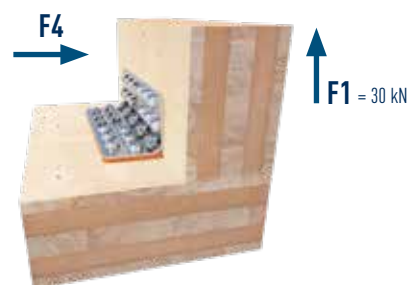

Load direction F2/F3/F4

Wood-to-wood connection

Vertical leg connection	Angle fitting screw Ø 5 x 50 n=3 GoFix [®] ZSS Ø 5 x 120 n=12
Horizontal leg connection	Angle fitting screw Ø 5 x 50 n=3 GoFix [®] ZSS Ø 5 x 120 n=12 GoFix [®] S+ Ø 10 x 125 n=5
Char. shear capacity $F_{2/3}$ [kN]	40,0
Char. shear capacity $F_{2/3}$ [kN] (use Mass-X [®] Angle decoupling Q HH)	36,0
Char. load-bearing capacity F_x [kN]	40,0
Char. load-bearing capacity $F_{2/3}$ [kN] (use Mass-X [®] Angle decoupling Q HH)	36,0

The load-bearing capacities were determined on the basis of ETA-23/0353. Characteristic load-bearing capacity in kN, wood strength class 350 kg/m³ char. bulk density. The minimum connection material edge distances for fasteners according to EC 5 must be observed. When used in timber frame construction, the minimum threshold height is 80 mm.

Caution: Check the assumptions made. The specified values, type and number of connecting materials represent a pre-dimensioning. Projects must be dimensioned exclusively by authorised persons in accordance with the State Building Code. For definitive proof of stability, please contact a structural engineer qualified according to the State Building Code (LBau0).

MASS-X[®] SHEAR

Panel connectors for absorbing shear forces

Advantages

- Many different areas of application
- For mounting in wood and concrete
- Very high shear carrying capacity thanks to new fastening concept
- Fewer connectors required

Instructions for use

For anchoring in wood, there are 6 angled screw holes per leg and 41 holes which are optionally **provided for angle fitting screws (WBS) or anchor nails**. Depending on the application, we have provided two additional partial utilisations of the fixing holes, which are also available as a type static calculation. Anchoring in concrete is done through the holes provided for this purpose (\varnothing 14 mm) using our **BeziFix[®] Anchor ZSS \varnothing 12,5 x 120 mm**.

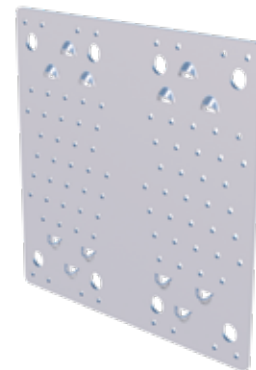

SIHGA [®] montagepack	PU	Dimension		Material	Material thickness [mm]
		Length [mm]	Width [mm]		
60806	10	230	240	S250 galvanised	3

To match:

GoFix[®] ZSS 5 x 120 mm, BeziFix[®] Anchor ZSS \varnothing 12,5 x 120 mm, Anchor nail and Angle fitting screw

ETA-23/0353

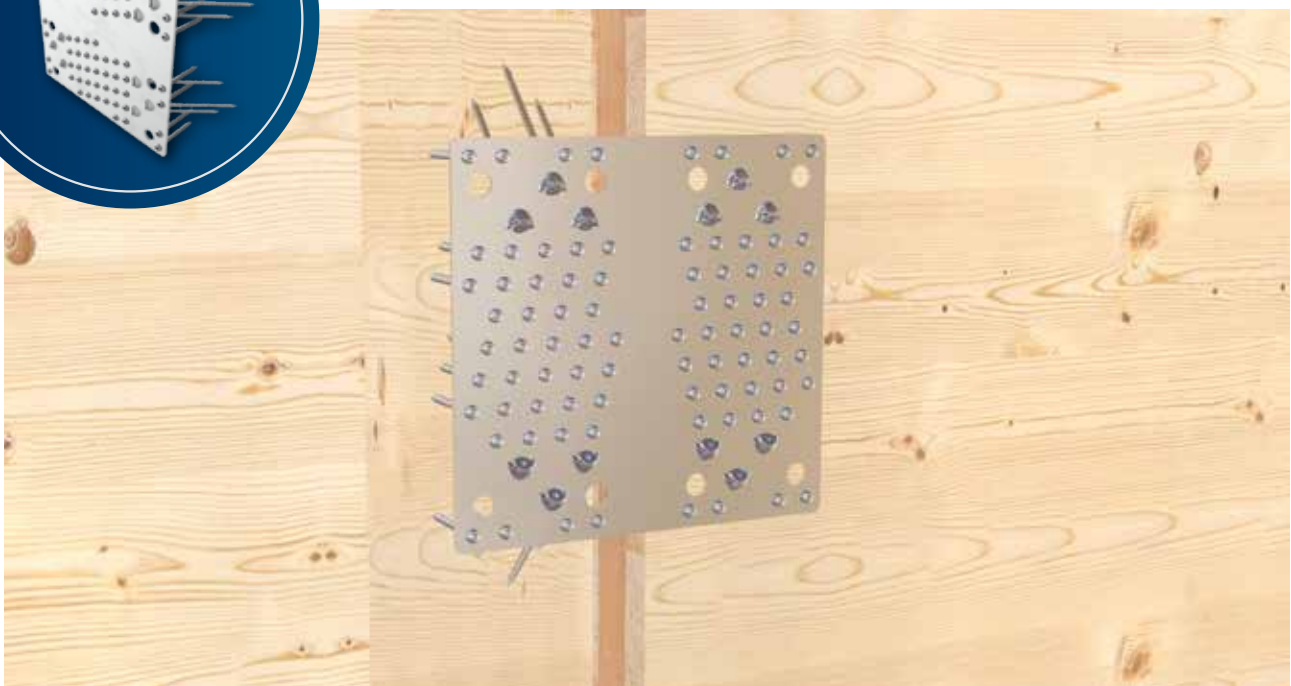
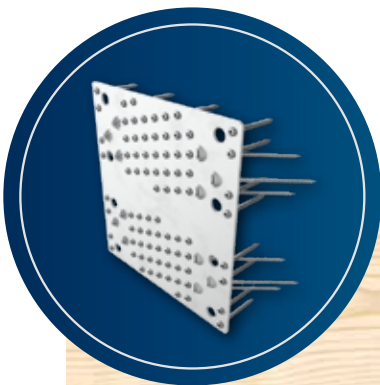

Mass-X[®] Shear for fixing two walls together.

MASS-X[®] SHEAR

Static values Full utilisation

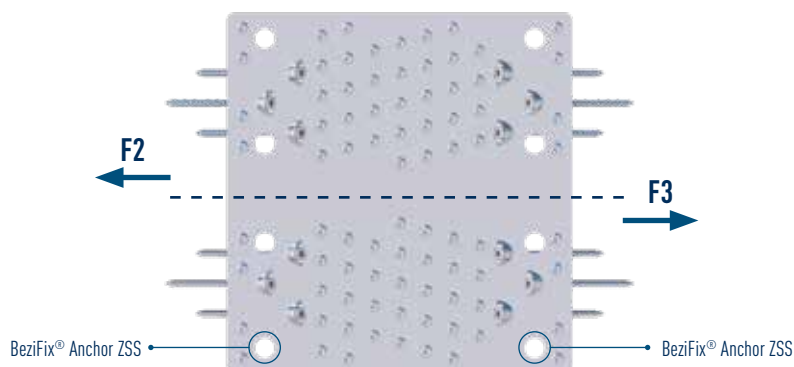

Load direction F2/3						
wood / wood	Fastening in the threshold and solid wood ceiling					Steel
	Connection fittings					
	Anchor nail			Angle fitting screw		
Dimension [mm]	4 x 40	4 x 50	4 x 60	5 x 50	5 x 60	S250
Number (n)	GoFix [®] ZSS 5 x 120 n = 6			41		
Char. shear capacity [kN]	37,3	44,3	47,9	44,6	47,6	156

Load direction F2/3							
wood / concrete	Fastening in the threshold				Fastening in the concrete ceiling		Steel
	Connection fittings						
	Anchor nail		Angle fitting screw		BeziFix [®] Anchor ZSS		
Dimension [mm]	4 x 40	4 x 50	4 x 60	5 x 50	5 x 60	Ø 12,5 x 120	S250
Number (n)	GoFix [®] ZSS 5 x 120 n = 6			41		2	
Char. shear capacity [kN] wood	37,3	44,3	47,9	44,6	47,6	-	156
Design value shear capacity [kN] concrete	-	-	-	-	-	36,2	-

The load-bearing capacities were determined on the basis of ETA-23/0353. Characteristic load-bearing capacity in kN, wood strength class 350 kg/m³ char. bulk density. The minimum connecting material edge distances according to EC 5 must be observed. Limit hole friction force according to EC3: $F_{b,RK} \phi 14 \text{ mm} = 93.75 \text{ kN}$
 The design values of the BeziFix[®] ZSS anchors were determined on the basis of ETA-16/0889 and EN 1992-4.

Edge parameters for design values on concrete: see page 11.

Caution: Check the assumptions made. The specified values, type and number of connecting materials represent a pre-dimensioning. Projects must be dimensioned exclusively by authorised persons in accordance with the State Building Code. For definitive proof of stability, please contact a structural engineer qualified according to the State Building Code (LBauO).

MASS-X[®] SHEAR

Partial utilisation 1 Half view

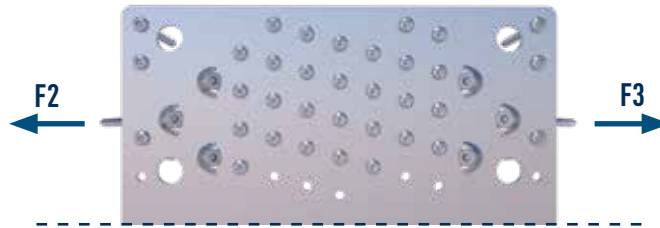

Load direction F2/3						
wood / wood	Fastening in the threshold and solid wood ceiling					Steel
	Connection fittings					
Dimension [mm]	Anchor nail		Angle fitting screw			S250
	4 x 40	4 x 50	4 x 60	5 x 50	5 x 60	
Number (n)	GoFix [®] ZSS 5 x 120 n = 6			34		156
Char. shear capacity [kN]	29,1	34,6	37,4	34,9	37,2	

Load direction F2/3							
wood / concrete	Fastening in the threshold				Fastening in the concrete ceiling		Steel
	Connection fittings						
Dimension [mm]	Anchor nail		Angle fitting screw		BeziFix [®] Anchor ZSS		S250
	4 x 40	4 x 50	4 x 60	5 x 50	5 x 60	Ø 12,5 x 120	
Number (n)	GoFix [®] ZSS 5 x 120 n = 6			34		2	156
Char. shear capacity [kN] wood	29,1	34,6	37,4	34,9	37,2	-	
Design value shear capacity [kN] concrete	-	-	-	-	-	36,2	-

The load-bearing capacities were determined on the basis of ETA-23/0353. Characteristic load-bearing capacity in kN, wood strength class 350 kg/m³ char. bulk density.

The minimum connecting material edge distances according to EC 5 must be observed. The design values of the BeziFix[®] ZSS anchors were determined on the basis of ETA-16/0889 and EN 1992-4.

Edge parameters for design values on concrete: see page 11

MASS-X[®] SHEAR

Partial utilisation 2 Half view

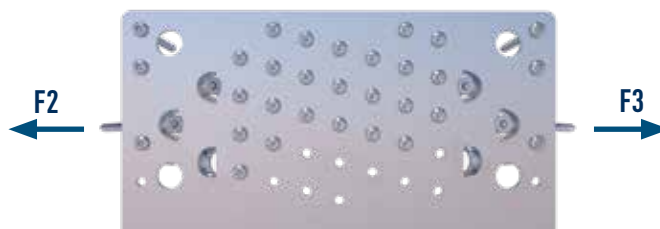

Load direction F2/3						
wood / wood	Fastening in the threshold and solid wood ceiling					Steel
	Connection fittings					
Dimension [mm]	Anchor nail		Angle fitting screw			S250
		4 x 40	4 x 50	4 x 60	5 x 50	
Number (n)	GoFix [®] ZSS 5 x 120 n = 4			29		
Char. shear capacity [kN]	23,6	28,0	30,4	28,3	30,1	156

Load direction F2/3							
wood / concrete	Fastening in the threshold			Fastening in the concrete ceiling			Steel
	Connection fittings						
Dimension [mm]	Anchor nail		Angle fitting screw		BeziFix [®] Anchor ZSS	S250	
		4 x 40	4 x 50	4 x 60	5 x 50		5 x 60
Number (n)	GoFix [®] ZSS 5 x 120 n = 4			29		2	
Char. shear capacity [kN] wood	23,6	28,0	30,4	28,3	30,1	-	156
Design value shear capacity [kN] concrete	-	-	-	-	-	36,2	-

The load-bearing capacities were determined on the basis of ETA-23/0353. Characteristic load-bearing capacity in kN, wood strength class 350 kg/m³ char. bulk density.

The minimum connecting material edge distances according to EC 5 must be observed. The design values of the BeziFix[®] ZSS anchors were determined on the basis of ETA-16/0889 and EN 1992-4.

Edge parameters for design values on concrete: see page 11

Caution: Check the assumptions made. The specified values, type and number of connecting materials represent a pre-dimensioning. Projects must be dimensioned exclusively by authorised persons in accordance with the State Building Code. For definitive proof of stability, please contact a structural engineer qualified according to the State Building Code (LBauO).

MASS-X[®] PULL ANGLE P-HB 340

The Mass-X[®] Pull Angle P-HB 340 is a steel sheet moulding especially for timber frame construction for the transmission of tensile forces. It enables simple and quick base point anchoring of timber elements in wood, steel or concrete substrates. The Mass-X[®] Pull Angle P-HB 340 is particularly stable and can withstand high loads.

Advantages

- Short bridge height (150 mm)
- Indirect fastening through an intermediate layer (e.g. OSB)
- For mounting on **wood and concrete**
- Optimised screw pattern for **very high tensile load capacities**
- In combination with the Mass-X[®] Pull Base Plate 60 the tensile force can be additionally increased

Instructions for use

The Mass-X[®] Pull Angle P-HB 340 is placed on the planking in the floor area and fastened to the stem and, if necessary, to the threshold with screws or anchor nails. The connection is capable of safely transferring tensile, suction and shear forces via the screws into the Mass-X[®] Pull Angle P-HB 340 and finally via a dowel into the base plate.

Maximum threshold height: 150 mm taking into account the distances to the end timber edge according to EC5



SIHGA [®] montagepack		Dimension	Material
Art. No.	PU	[mm]	
60766	5	340 x 63 x 60 x 3	S355 galvanised



Mass-X[®] Pull Angle P-HB 340 Application

MASS-X[®] PULL BASE PLATE 60



SIHGA [®] montagepack		Dimension		Material	Material thickness
Art. No.	PU	Length	Width		[mm]
		[mm]			
60776	5	50	58	S355 galvanised	10

MASS-X[®] PULL ANGLE P-HB 340

Static values

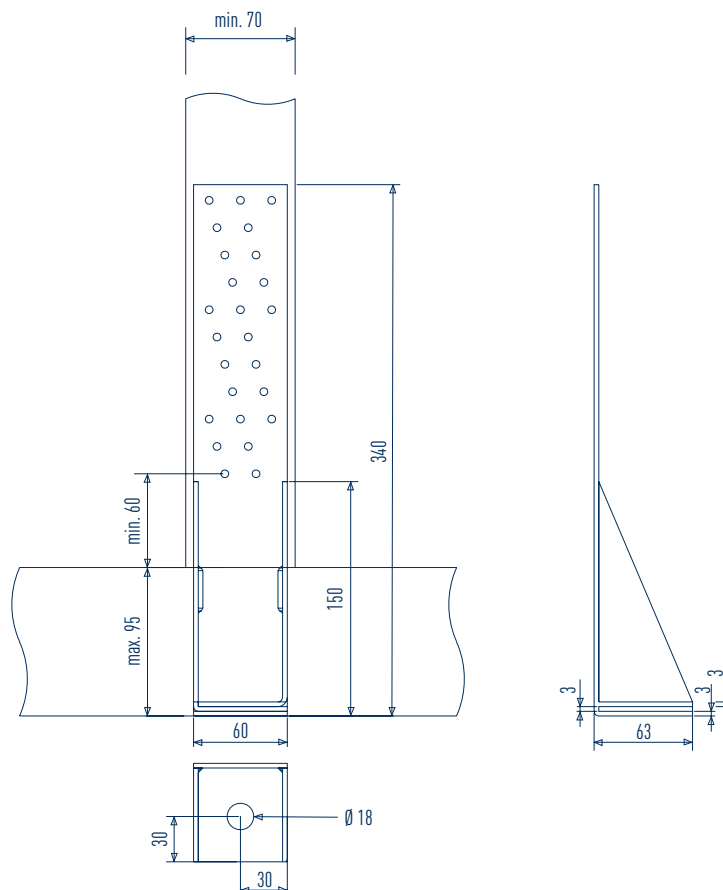

Load direction F1 (with pressure plate)										
wood / concrete	Fastening in mullion					Fastening in concrete				Steel
						Cracked	Uncracked	Cracked	Uncracked	
	Connection fittings					BeziFix [®] Anchor ZSS	BeziFix [®] Anchor ZSS	BeziFee [®] with threaded rod	BeziFee [®] with threaded rod	
	Anchor nail		Angle fitting screw			Ø 12,5 x 120	Ø 12,5 x 120	M16 5.8*	M16 5.8*	
Dimension [mm]	4 x 40	4 x 50	4 x 60	5 x 50	4 x 60	Ø 12,5 x 120	Ø 12,5 x 120	M16 5.8*	M16 5.8*	
Number [n]	25		25			1		1		
Char. tensile load capacity [kN] wood	28,3	33,4	34,4	41,3	44	-	-	-	-	
Design value tensile load capacity [kN] concrete	-	-	-	-	-	7,05	14,1	12	30	

* hef. 128 mm; concrete grade C25/30 cracked / uncracked

The load-bearing capacities were determined on the basis of ETA-23/0353. Characteristic load-bearing capacity in kN, wood strength class 350 kg/m³ char. bulk density.

The minimum connecting material edge distances according to EC 5 must be observed. The design values of the BeziFix[®] ZSS anchors were determined on the basis of ETA-16/0889 and EN 1992-4.

The design values for BeziFee[®] with M16 5.8 threaded rod were determined on the basis of ETA-17/0182 and TR029.

Edge parameters for design values on concrete: see page 11.

MASS-X[®] PULL HB 60 / 70

Straps developed for modern timber construction to absorb tensile forces

Advantages

- Many different areas of application
- For mounting in wood and concrete
- Very high tensile load capacity thanks to new fastening concept
- Fewer connectors required

Instructions for use

The anchoring in the wood is done using the **GoFix[®] ZSS 5 x 120 mm** at an angle of **45°**. Thanks to the holes specially provided for this purpose, which also serve as screw guides, a **friction-locked connection** is created between the screw head and the tension plate.

With the Mass-X[®] Pull HB 70, 2 holes of \varnothing 5 mm are provided for the 90° screw connection. **Anchoring in concrete** is done through the holes provided for this purpose (\varnothing 14 mm) using our **BeziFix[®] Anchor ZSS \varnothing 12,5 x 120**.

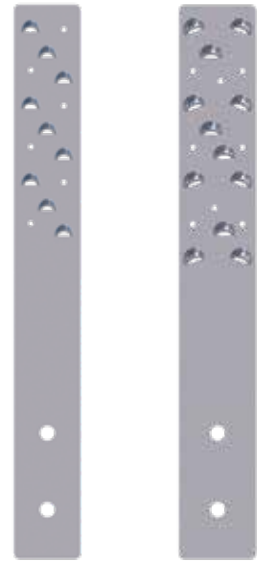

SIHGA [®] montagepack	Dimension Length	Dimension		Material	Material thickness
		Width			
Art. No.	PU	[mm]			[mm]
60976	10	506	60	S250 galvanised	3
60986	10	506	70	S250 galvanised	3

ETA-23/0353

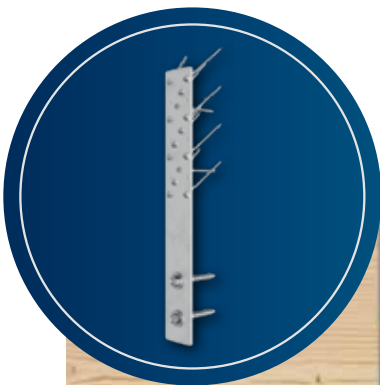

Mass-X[®] Pull HB 60 / 70 for fastening a wall to the foundation.

MASS-X[®] PULL HB 60 / 70

HB 60 - Static values

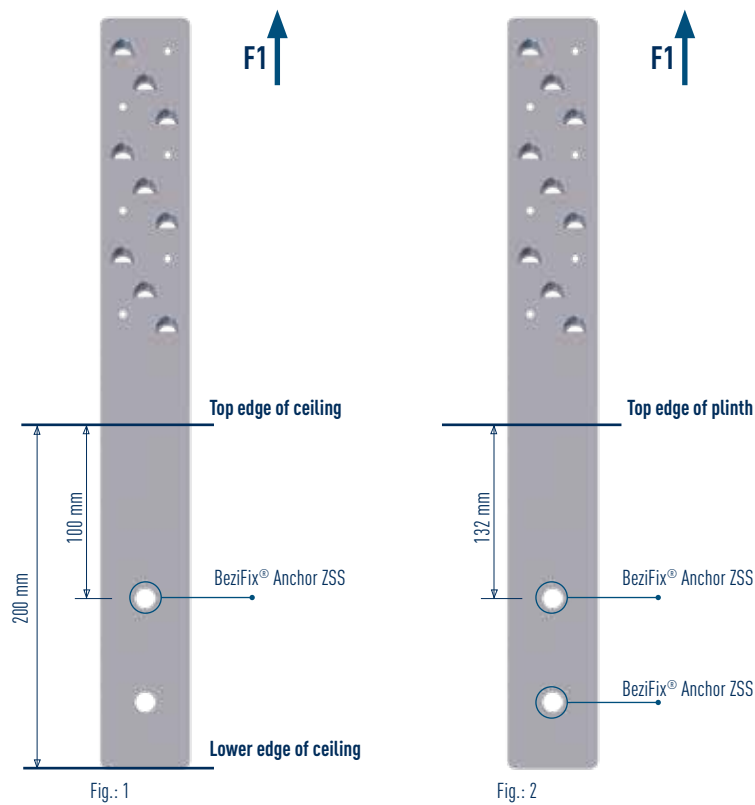

Load direction F1

Wood-to-concrete connection								
Connection wood side	GoFix [®] ZSS Ø 5 x 120 n=9		Anchor nail Ø 4 x 40 n=6		Anchor nail Ø 4 x 50 n=6		Anchor nail Ø 4 x 60 n=6	
Connection concrete side	BeziFix [®] Anchor ZSS Ø 12,5 x 120 n=1	BeziFix [®] Anchor ZSS Ø 12,5 x 120 n=2	BeziFix [®] Anchor ZSS Ø 12,5 x 120 n=1	BeziFix [®] Anchor ZSS Ø 12,5 x 120 n=2	BeziFix [®] Anchor ZSS Ø 12,5 x 120 n=1	BeziFix [®] Anchor ZSS Ø 12,5 x 120 n=2	BeziFix [®] Anchor ZSS Ø 12,5 x 120 n=1	BeziFix [®] Anchor ZSS Ø 12,5 x 120 n=2
Char. load-bearing capacity [kN] wood	23,8	23,8	9,3	9,3	11,0	11,0	11,4	11,4
D. v. load-bearing capacity [kN] concrete	12,7*	18,5**	12,7*	18,5**	12,7*	18,5**	12,7*	18,5**

Load direction F1

Wood-to-concrete connection								
Connection wood side	WBS Ø 5 x 50 n=6		WBS Ø 5 x 60 n=6		GoFix [®] ZSS Ø 5 x 120 n=9 + WBS Ø 5 x 50 n=6		GoFix [®] ZSS Ø 5 x 120 n=9 + WBS Ø 5 x 60 n=6	
Connection concrete side	BeziFix [®] Anchor ZSS Ø 12,5 x 120 n=1	BeziFix [®] Anchor ZSS Ø 12,5 x 120 n=2	BeziFix [®] Anchor ZSS Ø 12,5 x 120 n=1	BeziFix [®] Anchor ZSS Ø 12,5 x 120 n=2	BeziFix [®] Anchor ZSS Ø 12,5 x 120 n=1	BeziFix [®] Anchor ZSS Ø 12,5 x 120 n=2	BeziFix [®] Anchor ZSS Ø 12,5 x 120 n=1	BeziFix [®] Anchor ZSS Ø 12,5 x 120 n=2
Char. load-bearing capacity [kN] wood	12,0	12,0	13,1	13,1	27,4	27,4	27,7	27,7
D. v. load-bearing capacity [kN] concrete	12,7*	18,5**	12,7*	18,5**	12,7*	18,5**	12,7*	18,5**

Load direction F1

Wood-to-concrete connection							Steel 28,5 kN
Connection wood side	GoFix [®] ZSS Ø 5 x 120 n=9 + Anchor nail Ø 4 x 40 n=6		GoFix [®] ZSS Ø 5 x 120 n=9 + Anchor nail Ø 4 x 50 n=6		GoFix [®] ZSS Ø 5 x 120 n=9 + Anchor nail Ø 4 x 60 n=6		
Connection concrete side	BeziFix [®] Anchor ZSS Ø 12,5 x 120 n=1	BeziFix [®] Anchor ZSS Ø 12,5 x 120 n=2	BeziFix [®] Anchor ZSS Ø 12,5 x 120 n=1	BeziFix [®] Anchor ZSS Ø 12,5 x 120 n=2	BeziFix [®] Anchor ZSS Ø 12,5 x 120 n=1	BeziFix [®] Anchor ZSS Ø 12,5 x 120 n=2	
Char. load-bearing capacity [kN] wood	26,0	26,0	26,4	26,4	26,5	26,5	
D. v. load-bearing capacity [kN] concrete	12,7*	18,5**	12,7*	18,5**	12,7*	18,5**	

* 1 x BeziFix[®] anchor ZSS in the centre for a 20 cm thick concrete slab according to Figure 1; **2 x BeziFix[®] Anchor ZSS for a 20 cm thick concrete base according to Figure 2; The load-bearing capacities were determined on the basis of ETA-23/0353. Characteristic load-bearing capacity in kN, wood strength class 350 kg/m³ char. bulk density. The minimum connecting material edge distances according to EC 5 must be observed. The design values of the BeziFix[®] ZSS anchors were determined on the basis of ETA-16/0889 and EN 1992-4. **Edge parameters for design values on concrete: see page 11.**

MASS-X[®] PULL HB 60 / 70

HB 70 - Static values

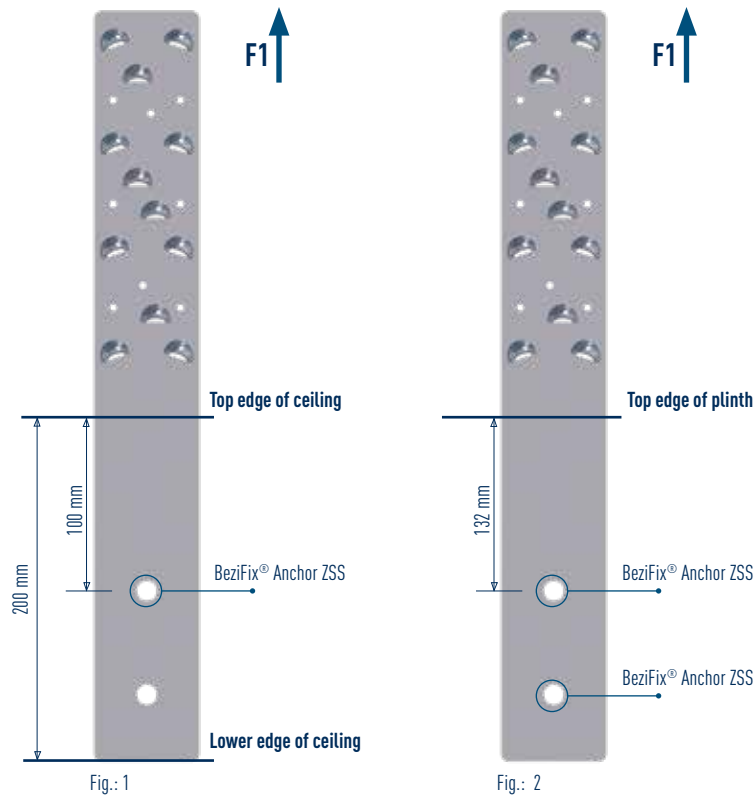

Load direction F1

Wood-to-concrete connection									
Connection wood side	GoFix [®] ZSS Ø 5 x 120 n=12		Anchor nail Ø 4 x 40 n=8		Anchor nail Ø 4 x 50 n=8		Anchor nail Ø 4 x 60 n=8		
Connection concrete side	BeziFix [®] Anchor ZSS Ø 12,5 x 120 n=1	BeziFix [®] Anchor ZSS Ø 12,5 x 120 n=2	BeziFix [®] Anchor ZSS Ø 12,5 x 120 n=1	BeziFix [®] Anchor ZSS Ø 12,5 x 120 n=2	BeziFix [®] Anchor ZSS Ø 12,5 x 120 n=1	BeziFix [®] Anchor ZSS Ø 12,5 x 120 n=2	BeziFix [®] Anchor ZSS Ø 12,5 x 120 n=1	BeziFix [®] Anchor ZSS Ø 12,5 x 120 n=2	
Char. load-bearing capacity [kN] wood	31,7	31,7	12,5	12,5	14,7	14,7	15,2	15,2	
D. v. load-bearing capacity [kN] concrete	12,7*	18,5**	12,7*	18,5**	12,7*	18,5**	12,7*	18,5**	

Load direction F1

Wood-to-concrete connection									
Connection wood side	WBS Ø 5 x 50 n=8		WBS Ø 5 x 60 n=8		GoFix [®] ZSS Ø 5 x 120 n=12 + WBS Ø 5 x 50 n=8		GoFix [®] ZSS Ø 5 x 120 n=12 + WBS Ø 5 x 60 n=8		
Connection concrete side	BeziFix [®] Anchor ZSS Ø 12,5 x 120 n=1	BeziFix [®] Anchor ZSS Ø 12,5 x 120 n=2	BeziFix [®] Anchor ZSS Ø 12,5 x 120 n=1	BeziFix [®] Anchor ZSS Ø 12,5 x 120 n=2	BeziFix [®] Anchor ZSS Ø 12,5 x 120 n=1	BeziFix [®] Anchor ZSS Ø 12,5 x 120 n=2	BeziFix [®] Anchor ZSS Ø 12,5 x 120 n=1	BeziFix [®] Anchor ZSS Ø 12,5 x 120 n=2	
Char. load-bearing capacity [kN] wood	18,2	18,2	19,0	19,0	37,16	37,16	37,4	37,4	
D. v. load-bearing capacity [kN] concrete	12,7*	18,5**	12,7*	18,5**	12,7*	18,5**	12,7*	18,5**	

Load direction F1

Wood-to-concrete connection								Steel 37,4 kN
Connection wood side	GoFix [®] ZSS Ø 5 x 120 n=12 + Anchor nail Ø 4 x 40 n=8		GoFix [®] ZSS Ø 5 x 120 n=12 + Anchor nail Ø 4 x 50 n=8		GoFix [®] ZSS Ø 5 x 120 n=12 + Anchor nail Ø 4 x 60 n=8			
Connection concrete side	BeziFix [®] Anchor ZSS Ø 12,5 x 120 n=1	BeziFix [®] Anchor ZSS Ø 12,5 x 120 n=2	BeziFix [®] Anchor ZSS Ø 12,5 x 120 n=1	BeziFix [®] Anchor ZSS Ø 12,5 x 120 n=2	BeziFix [®] Anchor ZSS Ø 12,5 x 120 n=1	BeziFix [®] Anchor ZSS Ø 12,5 x 120 n=2		
Char. load-bearing capacity [kN] wood	34,7	34,7	35,2	35,2	35,4	35,4		
D. v. load-bearing capacity [kN] concrete	12,7*	18,5**	12,7*	18,5**	12,7*	18,5**		

* 1 x BeziFix[®] anchor ZSS in the centre for a 20 cm thick concrete slab according to Figure 1; **2 x BeziFix[®] Anchor ZSS for a 20 cm thick concrete base according to Figure 2; The load-bearing capacities were determined on the basis of ETA-23/0353. Characteristic load-bearing capacity in kN, wood strength class 350 kg/m³ char. bulk density.

The minimum connecting material edge distances according to EC 5 must be observed. The design values of the BeziFix[®] ZSS anchors were determined on the basis of ETA-16/0889 and EN 1992-4.

Edge parameters for design values on concrete: see page 11.

MASS-X[®] PULL HH 60 / 70

Straps developed for modern timber construction to absorb tensile forces

Advantages

- Many different areas of application
- For mounting in wood
- Very high tensile load capacity thanks to new fastening concept
- Fewer connectors required

Instructions for use

The anchoring in the wood is done using the **GoFix[®] ZSS 5 x 120 mm at an angle of 45°**. Thanks to the holes specially provided for this purpose which also serve as screw guides, a **friction-locked connection** is created between the screw head and the tension strap. The Mass-X[®] Pull HH 70 also has 2 holes of $\varnothing 5$ mm which are provided for the 90° screw connection.



SIHGA [®]		Dimension		Material	Material thickness
montagepack	PU	Length	Width		
Art. No.		[mm]			[mm]
60786	10	680	60	S250 galvanised	3
60796	10	740	70	S250 galvanised	3

ETA-23/0353

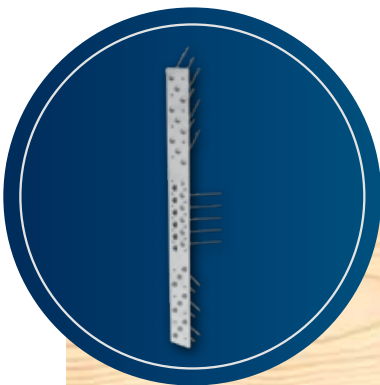

Mass-X[®] Pull HH 60 / 70 for fastening wall to ceiling elements.

MASS-X[®] PULL HH 60 / 70

HH 60 - Static values



Load direction F1

Wood-to-wood connection							Steel 28,5 kN
Connection leg 1	GoFix [®] ZSS Ø 5 x 120 n=9	WBS Ø 5 x 50 n=6	WBS Ø 5 x 60 n=6	Anchor nail Ø 4 x 40 n=6	Anchor nail Ø 4 x 50 n=6	Anchor nail Ø 4 x 60 n=6	
Connection leg 2	GoFix [®] ZSS Ø 5 x 120 n=9	WBS Ø 5 x 50 n=6	WBS Ø 5 x 60 n=6	Anchor nail Ø 4 x 40 n=6	Anchor nail Ø 4 x 50 n=6	Anchor nail Ø 4 x 60 n=6	
Char. Tensile load capacity [kN]	23,8	12	13,1	9,4	11	11,4	

Load direction F1

Wood-to-wood connection						Steel 28,5 kN
Connection leg 1	GoFix [®] ZSS Ø 5 x 120 n=9 + WBS Ø 5 x 50 n=6	GoFix [®] ZSS Ø 5 x 120 n=9 + WBS Ø 5 x 60 n=6	GoFix [®] ZSS Ø 5 x 120 n=9 + Anchor nail Ø 4 x 40 n=6	GoFix [®] ZSS Ø 5 x 120 n=9 + Anchor nail Ø 4 x 50 n=6	GoFix [®] ZSS Ø 5 x 120 n=9 + Anchor nail Ø 4 x 60 n=6	
Connection leg 2	GoFix [®] ZSS Ø 5 x 120 n=9 + WBS Ø 5 x 50 n=6	GoFix [®] ZSS Ø 5 x 120 n=9 + WBS Ø 5 x 60 n=6	GoFix [®] ZSS Ø 5 x 120 n=9 + Anchor nail Ø 4 x 40 n=6	GoFix [®] ZSS Ø 5 x 120 n=9 + Anchor nail Ø 4 x 50 n=6	GoFix [®] ZSS Ø 5 x 120 n=9 + Anchor nail Ø 4 x 60 n=6	
Char. load-bearing capacity [kN] wood	27,4	27,7	26,0	26,4	26,5	

The load-bearing capacities were determined on the basis of ETA-23/0353. Characteristic load-bearing capacity in kN, wood strength class 350 kg/m³ char. bulk density. The minimum connecting material edge distances according to EC 5 must be observed.

Caution: Check the assumptions made. The specified values, type and number of connecting materials represent a pre-dimensioning. Projects must be dimensioned exclusively by authorised persons in accordance with the State Building Code. For definitive proof of stability, please contact a structural engineer qualified according to the State Building Code (LBauO).

HH 70 - Static values



Load direction F1

Wood-to-wood connection							Steel 37,4 kN
Connection leg 1	GoFix [®] ZSS Ø 5 x 120 n=12	Anchor nail Ø 4 x 40 n=8	Anchor nail Ø 4 x 50 n=8	Anchor nail Ø 4 x 60 n=8	WBS Ø 5 x 50 n=8	WBS Ø 5 x 60 n=8	
Connection leg 2	GoFix [®] ZSS Ø 5 x 120 n=12	Anchor nail Ø 4 x 40 n=8	Anchor nail Ø 4 x 50 n=8	Anchor nail Ø 4 x 60 n=8	WBS Ø 5 x 50 n=8	WBS Ø 5 x 60 n=8	
Char. Tensile load capacity [kN]	31,7	12,5	14,7	15,2	18,2	19,4	

Load direction F1

Wood-to-wood connection						Steel 37,4 kN
Connection leg 1	GoFix [®] ZSS Ø 5 x 120 n=12 + WBS Ø 5 x 50 n=8	GoFix [®] ZSS Ø 5 x 120 n=12 + WBS Ø 5 x 60 n=8	GoFix [®] ZSS Ø 5 x 120 n=12 + Anchor nail Ø 4 x 40 n=8	GoFix [®] ZSS Ø 5 x 120 n=12 + Anchor nail Ø 4 x 50 n=8	GoFix [®] ZSS Ø 5 x 120 n=12 + Anchor nail Ø 4 x 60 n=8	
Connection leg 2	GoFix [®] ZSS Ø 5 x 120 n=12 + WBS Ø 5 x 50 n=8	GoFix [®] ZSS Ø 5 x 120 n=12 + WBS Ø 5 x 60 n=8	GoFix [®] ZSS Ø 5 x 120 n=12 + Anchor nail Ø 4 x 40 n=8	GoFix [®] ZSS Ø 5 x 120 n=12 + Anchor nail Ø 4 x 50 n=8	GoFix [®] ZSS Ø 5 x 120 n=12 + Anchor nail Ø 4 x 60 n=8	
Char. load-bearing capacity [kN] wood	37,16	37,4	34,7	35,2	35,4	

The load-bearing capacities were determined on the basis of ETA-23/0353. Characteristic load-bearing capacity in kN, wood strength class 350 kg/m³ char. bulk density. The minimum connecting material edge distances according to EC 5 must be observed.

Caution: Check the assumptions made. The specified values, type and number of connecting materials represent a pre-dimensioning. Projects must be dimensioned exclusively by authorised persons in accordance with the State Building Code. For definitive proof of stability, please contact a structural engineer qualified according to the State Building Code (LBauO).

IDEFIX® DWD 308 / 410

Shear-resistant connection of wall and ceiling elements

Advantages

- Connects solid wood elements parallel and over corners
- For mounting in wood
- Shear-resistant connections of timber elements of all sizes and types
- Proven three-dimensional load absorption due to geometry and 45° bolting

Instructions for use

For parallel joints, drill with IdeFix® drill IB HMB together with IdeFix® drill bell IBG.
For corner joints, drill only with IdeFix® drill IB HMB.



SIHGA® montagepack		IFK	Dimension	
Art. No.	PU	d x h	GoFix® HK	Pressure dome
28906	5	40 x 25	6,0 x 100	16 x 25
28896	5	30 x 20	5,0 x 80	12 x 20



ETA-14/0160



IdeFix® DWD 308 / 410 for fastening wall and ceiling elements.

IDEFIX[®] DWD 308 / 410

Static values

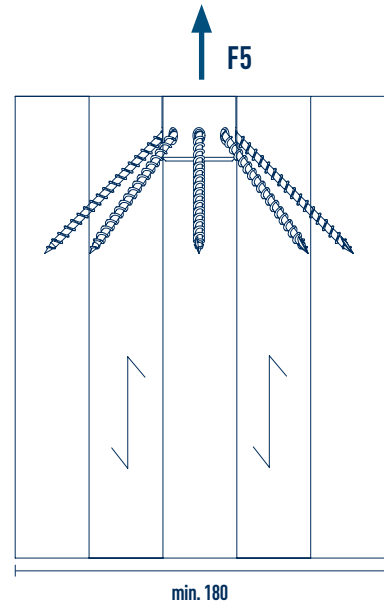
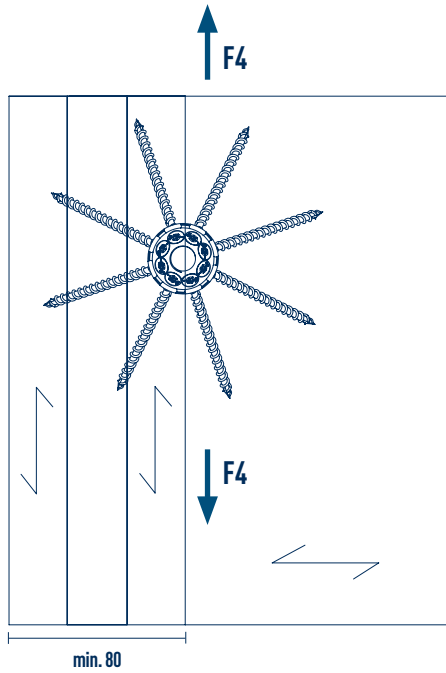

Corner joint

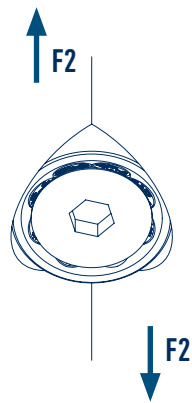

Parallel joint

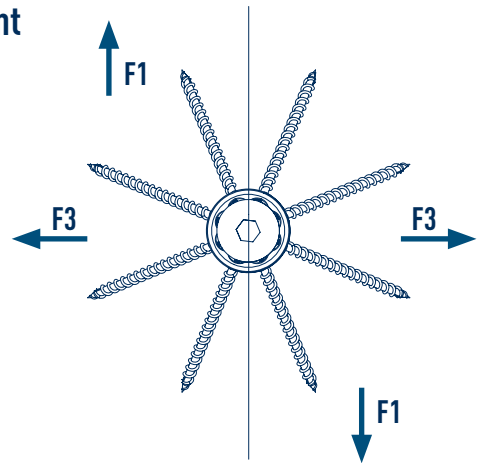

Minimum axis distances

Typ	X	Y
IdeFix [®] DWD	[mm]	[mm]
IFK 308	80	80
IFK 410	100	100

Dimension	Dimension	Dimension	Characteristic value parallel	Characteristic value corner joint
IFK	GoFix [®] HK	Pressure dome	F1	F2
d x h	d x L	d x L	[kN]	[kN]
30 x 20	5,0 x 80	12 x 20	14,30	6,33
40 x 25	6,0 x 100	16 x 25	20,36	8,99

Dimension	Dimension	Dimension	Characteristic value corner joint	Characteristic value corner joint	Characteristic value extract
IFK	GoFix [®] HK	Pressure dome	F3	F4	F5
d x h	d x L	d x L	[kN]	[kN]	[kN]
30 x 20	5,0 x 80	12 x 20	8,27	12,61	31,66
40 x 25	6,0 x 100	16 x 25	11,75	20,36	44,98

BEZIFIX® ANCHOR ZF/ZS/ZSS

For dowel-free fixing in concrete

Advantages

- Ideal for fastening close to the edge, no spreading effect
- Simple push-through mounting
- Easy screwing into the pre-drilled concrete is made possible by the sawtooth thread in the front area
- Only hand-tightening is required to achieve full load capacity

Instructions for use

Pay attention to the correct drill diameter and drill quality -> that is why the drill is included. Use a tangential impact wrench for processing.

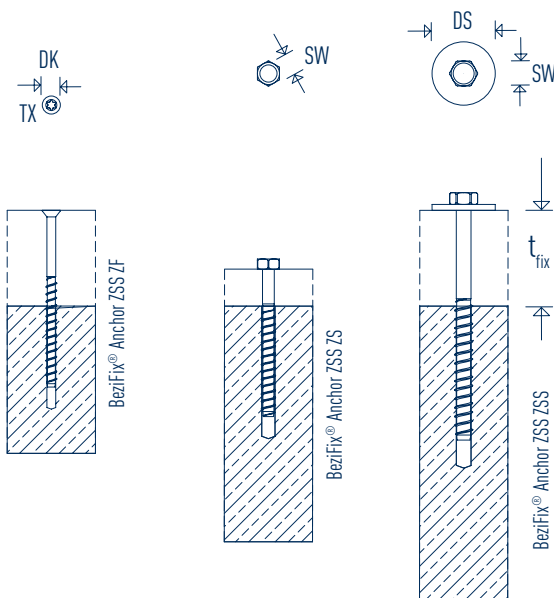

BeziFix® Anchor ZSS/ZS embedded in wall.

SIHGA®		Dimension	Mounting thickness	Dimension	
montagepack	BeziFix® Anchor ZF	d1 x L	t _{fix}	drive	DK
Art. No.	PU		[mm]	TX	[mm]
41306	100	7,5 x 40	5	40	13
41316	100	7,5 x 60	5	40	13
41326	100	7,5 x 80	25	40	13
41336	100	7,5 x 100	45	40	13
41346	100	7,5 x 120	65	40	13
41356	100	7,5 x 140	85	40	13
41366	100	7,5 x 160	105	40	13

montagepack		BeziFix® Anchor ZS	t _{fix}	SW
Art. No.	PU	d1 x L	[mm]	[mm]
41506	50	10,5 x 60	5	15
41516	50	10,5 x 80	5	15
41526	50	10,5 x 100	25	15
41536	50	10,5 x 120	45	15
41546	50	10,5 x 140	65	15
41556	50	10,5 x 160	85	15

montagepack		BeziFix® Anchor ZSS	t _{fix}	SW	DS
Art. No.	PU	d1 x L	[mm]	[mm]	[mm]
41806	30	12,5 x 80	5	17	44
41816	30	12,5 x 100	5	17	44
41826	30	12,5 x 120	25	17	44
41836	30	12,5 x 140	45	17	44
41846	30	12,5 x 160	65	17	44
41856	30	12,5 x 180	85	17	44
41866	30	12,5 x 200	105	17	44
41876	30	12,5 x 240	145	17	44
41886	30	12,5 x 280	185	17	44
41896	30	12,5 x 320	225	17	44

ETA-16/0889
Option 1



BEZIFIX[®] ANCHOR ZF/ZS/ZSS

Static values

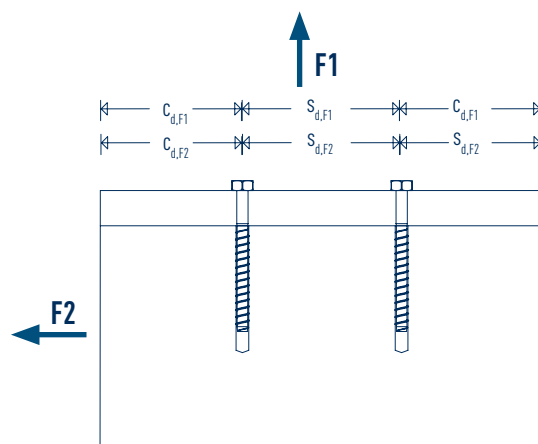

SIHGA [®]	Bezifix [®] Anchor ZSS		ZF	ZS	ZSS
Coating			SC 12	SC 12	SC 4
Diameter	\emptyset	[mm]	7,5	10,5	12,5
Screw-in depth	h_{nom}	[mm]	55	75	95
Effective anchorage depth	h_{ef}	[mm]	41	55	71
Drilling diameter concrete	d_o	[mm]	6,0	9,0	10,0
Drill hole depth	h_i	[mm]	70	90	110
Min. concrete thickness	h_{min}	[mm]	100	160	200
Max. starting torque	T_{max}	[Nm]	250	450	450
Min. edge and axis distances without load influence		[mm]	40	55	65

Notice

„SIHGA[®] Jointplan“ design software at www.sihga.com/service/online-planung/ for downloading.



GOFIX[®] X+

Fixes blunt wood joints extremely quickly

Advantages

- Transmits high tensile, compressive and shear forces
- The optimised geometry of the drill tip allows for quick attachment and simultaneous pre-drilling
- Screwing at 0° to the grain is permissible: can be installed in all positions and angles in cross-laminated timber
- Special cylinder head: infinitely sinkable without splitting effect

Instructions for use

For precise and fast series production of cross fittings, we recommend the professional assembly tool. For easier screwing-in, use the screwing tool GoFix[®] ESH 8. The GoFix[®] X+ can also be pre-drilled; X+ 6.5 with Ø 4 mm, X+ 8.0 with Ø 5 mm.



Dimension [mm]

GoFix [®] X+		
d1	TX	DK
6,5	30	8,0
8,0	40	10,0
10,0	50	13,0

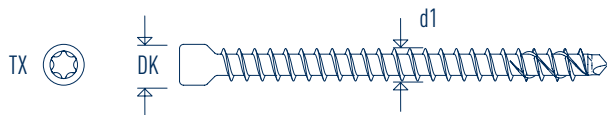

ETA-11/0425

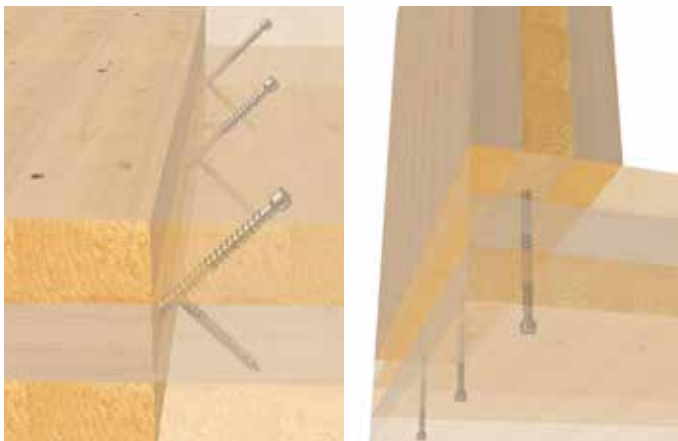

GoFix[®] X+ Application in cross-laminated timber.



To match:

GoFix[®] X+ System case
for GoFix[®] X+ 6,5 and 8,0 mm
(Art. No.: 49650, 49700)

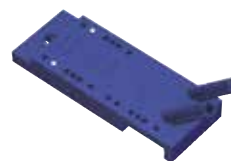

To match:

GoFix[®] X+ SL setting gauge
for GoFix[®] X+ 6,5 and 8,0 mm
(Art. No.: 31356, 31406)



To match:

GoFix[®] X+ MW mounting bracket
for GoFix[®] X+ 6,5 and 8,0 mm
(Art. No.: 31456, 31486, 31506,
31536)

GOFIX[®] X+

Static values

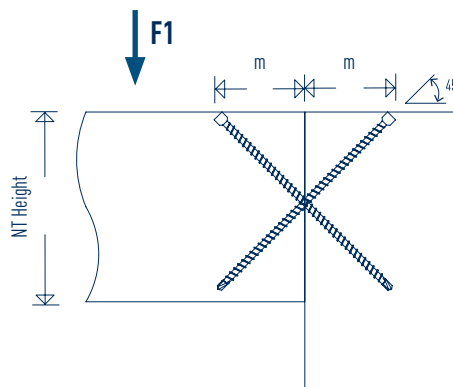
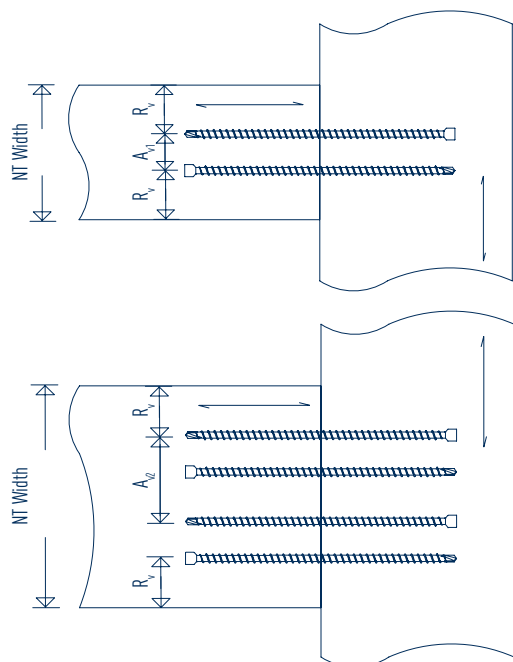

Dimension [mm]

GoFix [®] X+					
d1	TX	DK	R _v	A _v	A _v
6,5	30	8,0	20	10	33
8,0	40	10,0	24	12	40
10,0	50	13,0	30	15	50

SIHGA [®]		Dimension	Secondary beam	Assembly dimension		Transverse force F1 - 1 pair		Transverse force F1 - 2 pairs		
montagepack	PU	GoFix [®] X+	NT Height	m	NT Width min.	Char. values*	Design values**	NT Width min.	Char. values*	Design values**
Art. No.	PU	d1 x L	min. [mm]	[mm]	[mm]	[kN]	[kN]	[mm]	[kN]	[kN]
42066	150	6,5 x 195	140	70	50	10,88		85	21,77	
42246	75	8,0 x 220	160	80	60	13,19		100	26,37	
42256	75	8,0 x 245	180	90	60	14,76		100	29,51	
42276	75	8,0 x 295	220	110	60	17,90		100	35,79	
42286	75	8,0 x 330	240	120	60	20,09		100		0,00
42296	75	8,0 x 375	270	135	60		15,89	100		31,78
42306	75	8,0 x 400	290	145	60		15,89	100		31,78
42316	75	8,0 x 430	310	155	60		15,89	100		31,78
42326	75	8,0 x 480	350	170	60		15,89	100		31,78
42666	50	10,0 x 300	220	110	75	22,15		125	44,29	
42676	50	10,0 x 330	240	120	75	24,44		125	48,88	
42686	50	10,0 x 360	260	130	75	26,73		125	53,46	
42696	50	10,0 x 400	290	145	75		22,43	125		44,86
42706	50	10,0 x 450	320	160	75		22,43	125		44,86
42716	50	10,0 x 500	360	180	75		22,43	125		44,86
42726	50	10,0 x 550	400	200	75		22,43	125		44,86
42736	50	10,0 x 600	430	215	75		22,43	125		44,86

Subject to technical modifications and errors. Status of approval 05.2023

* Characteristic values for measurement according to EC 5, bulk density $\rho_k = 350 \text{ kg/m}^3$ (C24)

** Design values according to EC 3 due to buckling ($\gamma_M = 1.1$ already taken into account)

GOFIX[®] X+

Static values

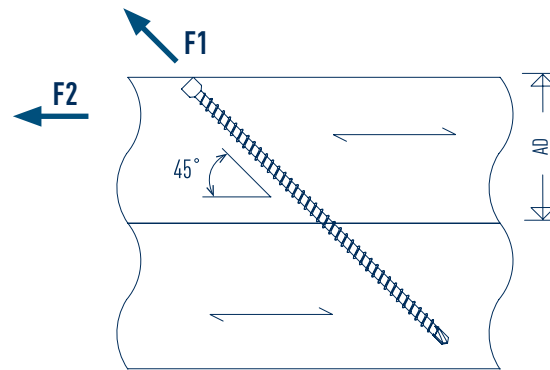

Art. No.	SIHGA [®] montagepack	PU	Dimension GoFix [®] X+	Attachment thickness Wood AD [mm]	Characteristic values*	
					Tensile force F1 [kN]	Transverse force F2 [kN]
42026		150	6,5 x 120	45	4,08	2,88
42036		150	6,5 x 140	50	4,82	3,41
42046		150	6,5 x 160	60	5,56	3,93
42066		150	6,5 x 195	70	6,85	4,85
42226		75	8,0 x 155	60	6,44	4,55
42236		75	8,0 x 195	70	8,21	5,81
42246		75	8,0 x 220	80	9,32	6,59
42256		75	8,0 x 245	90	10,43	7,38
42276		75	8,0 x 295	105	12,65	8,95
42286		75	8,0 x 330	120	14,21	10,05
42296		75	8,0 x 375	135	16,21	11,46
42306		75	8,0 x 400	145	17,32	12,24
42316		75	8,0 x 430	155	18,65	13,19
42326		75	8,0 x 480	170	20,87	14,76
42666		50	10,0 x 300	110	15,66	11,07
42676		50	10,0 x 330	120	17,28	12,22
42686		50	10,0 x 360	130	18,90	13,36
42696		50	10,0 x 400	145	21,06	14,89
42706		50	10,0 x 450	160	23,76	16,80
42716		50	10,0 x 500	180	26,46	18,71
42726		50	10,0 x 550	195	29,16	20,62
42736		50	10,0 x 600	215	31,86	22,53

Subject to technical modifications and errors. Status of approval 05.2023

* Characteristic values for measurement according to EC 5, bulk density $\rho_k = 350 \text{ kg/m}^3$ (C24)

GOFIX[®] X+

Static values

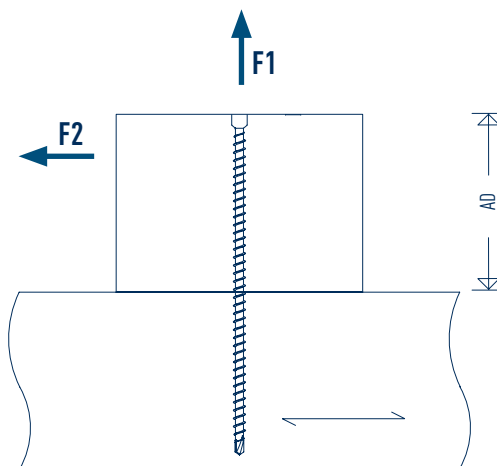

Art. No.	SIHGA [®] montagepack	PU	Dimension GoFix [®] X+	Attachment thickness Wood AD [mm]	Characteristic values 90°*	
					Tensile force F1 [kN]	Transverse force F2 [kN]
42026		150	6,5 x 120	60	4,08	3,25
42036		150	6,5 x 140	70	4,82	3,43
42046		150	6,5 x 160	80	5,56	3,62
42066		150	6,5 x 195	100	6,85	3,94
42226		75	8,0 x 155	80	6,39	4,77
42236		75	8,0 x 195	100	8,17	5,21
42246		75	8,0 x 220	110	9,28	5,49
42256		75	8,0 x 245	125	10,39	5,77
42276		75	8,0 x 295	150	12,61	6,32
42286		75	8,0 x 330	170	14,16	6,71
42296		75	8,0 x 375	190	16,16	7,21
42306		75	8,0 x 400	200	17,27	7,49
42316		75	8,0 x 430	215	18,60	7,82
42326		75	8,0 x 480	240	20,82	8,37
42666		50	10,0 x 300	150	15,55	8,33
42676		50	10,0 x 330	170	17,17	8,73
42686		50	10,0 x 360	180	18,79	9,14
42696		50	10,0 x 400	200	20,95	9,68
42706		50	10,0 x 450	225	23,65	10,35
42716		50	10,0 x 500	250	26,35	11,03
42726		50	10,0 x 550	275	29,05	11,70
42736		50	10,0 x 600	300	31,75	12,38

Subject to technical modifications and errors. Status of approval 05.2023

* Characteristic values for measurement according to EC 5, bulk density $\rho_k = 350 \text{ kg/m}^3$ (C24)

GOFIX[®] X+

Static values

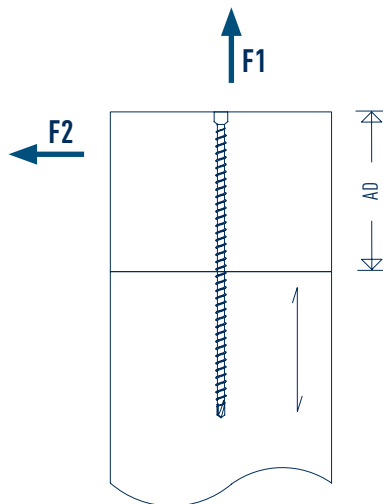

Art. No.	SIHGA [®] montagepack	PU	Dimension GoFix [®] X+	Attachment thickness Wood AD [mm]	Characteristic values 0**	
					Tensile force F1 [kN]	Transverse force F2 [kN]
42026		150	6,5 x 120	60	1,22	1,50
42036		150	6,5 x 140	70	1,44	1,91
42046		150	6,5 x 160	80	1,67	1,97
42066		150	6,5 x 195	100	2,06	2,06
42226		75	8,0 x 155	80	1,92	2,61
42236		75	8,0 x 195	100	2,45	2,75
42246		75	8,0 x 220	110	2,78	2,83
42256		75	8,0 x 245	125	3,12	2,91
42276		75	8,0 x 295	150	3,78	3,08
42286		75	8,0 x 330	170	4,25	3,20
42296		75	8,0 x 375	190	4,85	3,35
42306		75	8,0 x 400	200	5,18	3,43
42316		75	8,0 x 430	215	5,58	3,53
42326		75	8,0 x 480	240	6,25	3,70
42666		50	10,0 x 300	150	4,67	4,07
42676		50	10,0 x 330	170	5,15	4,19
42686		50	10,0 x 360	180	5,64	4,32
42696		50	10,0 x 400	200	6,29	4,48
42706		50	10,0 x 450	225	7,10	4,68
42716		50	10,0 x 500	250	7,91	4,88
42726		50	10,0 x 550	275	8,72	5,09
42736		50	10,0 x 600	300	9,53	5,29

Subject to technical modifications and errors. Status of approval 05.2023

* Characteristic values for measurement according to EC 5, bulk density $\rho_k = 350 \text{ kg/m}^3$ (C24)

GOFIX® X+

Application of GoFix® X+ SL setting gauge

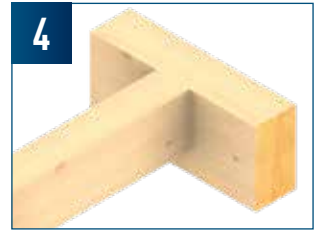
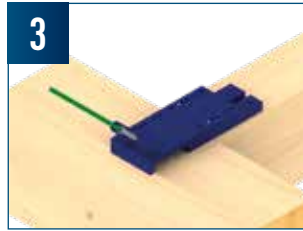
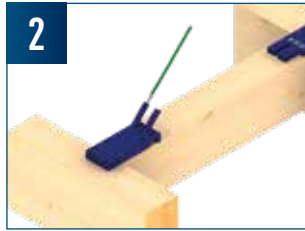
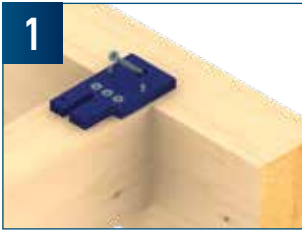

Application of GoFix® X+ MW mounting bracket

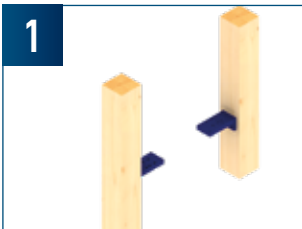

GOFIX[®] S+

Attaches steel parts to wood

Advantages

- Ideal for suspending wooden ceilings from steel beams, fixing steel angles to wooden beams, suspensions with steel supports
- Permanent, secure and friction-locked fastening
- Load forces are optimally transferred from the wood to the steel part
- Processing with impact wrenches

Instructions for use

Observe edge and axis distances. For easier screwing-in, use the screwing tool GoFix[®] ESH 8.

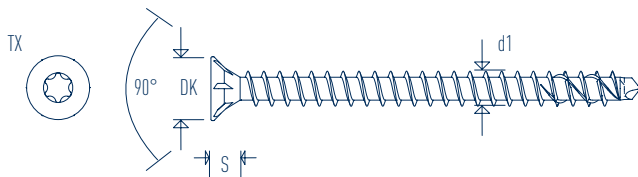

Dimension [mm]

GoFix[®] S+

d1	TX	DK	S
8,0	40	15,0	5,5
10,0	50	18,3	6,5

ETA-11/0425



GoFix[®] S+ with SIHGA[®] drill tip and optimised thread.



To match:

GoFix[®] ESH 8 screw-in tool for GoFix[®] types X+ / S+ / SH (Art. No.: 31446)

GOFIX[®] S+

Static values

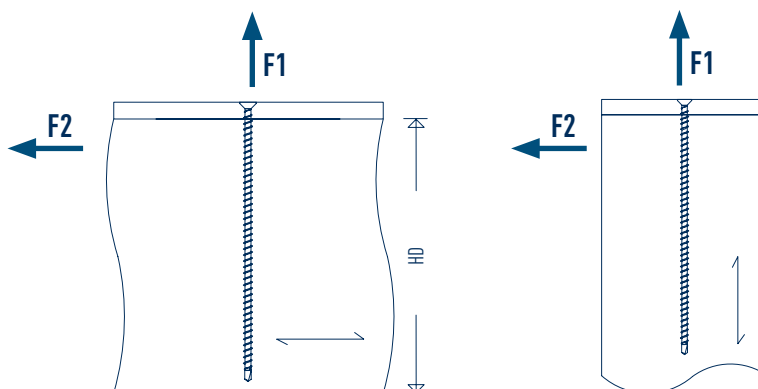

SIHGA [®] montagepack		Dimension GoFix [®] S+	Wooden component HD	Characteristic values 90°*		Characteristic values 0°*	
Art. No.	PU	d1 x L	[mm]	Tensile force F1 [kN]	Transverse force F2 [kN]	Tensile force F1 [kN]	Transverse force F2 [kN]
42406	75	8,0 x 95	100	6,66	6,07	2,00	3,52
42416	75	8,0 x 125	130	9,32	6,81	2,80	3,72
42426	75	8,0 x 155	160	11,90	7,46	3,57	3,91
42436	75	8,0 x 195	200	15,45	8,34	4,64	4,18
42446	75	8,0 x 220	230	17,67	8,90	5,30	4,34
42456	75	8,0 x 245	250	19,89	9,45	5,97	4,51
42466	75	8,0 x 270	280	22,11	10,01	6,63	4,68
42476	75	8,0 x 295	300	24,33	10,56	7,30	4,84
42486	75	8,0 x 330	340	25,00	10,73	8,23	5,08
42496	75	8,0 x 375	380	25,00	10,73	9,43	5,38
42506	75	8,0 x 400	410	25,00	10,73	10,10	5,54
42516	75	8,0 x 430	440	25,00	10,73	10,90	5,74
42526	75	8,0 x 480	490	25,00	10,73	12,23	6,08
42806	50	10,0 x 125	130	11,23	9,09	3,37	4,95
42816	50	10,0 x 155	160	14,47	9,90	4,34	5,20
42826	50	10,0 x 195	200	18,79	10,98	5,64	5,52
42836	50	10,0 x 220	230	21,49	11,65	6,45	5,72
42846	50	10,0 x 245	250	24,19	12,33	7,26	5,93
42856	50	10,0 x 270	280	26,89	13,00	8,07	6,13
42866	50	10,0 x 300	310	30,13	13,81	9,04	6,37
42876	50	10,0 x 330	340	33,00	14,53	10,01	6,61
42886	50	10,0 x 360	370	33,00	14,53	10,98	6,86
42896	50	10,0 x 400	410	33,00	14,53	12,28	7,18
42906	50	10,0 x 450	460	33,00	14,53	13,90	7,59
42916	50	10,0 x 500	510	33,00	14,53	15,52	7,99
42926	50	10,0 x 550	560	33,00	14,53	17,14	8,40
42936	50	10,0 x 600	610	33,00	14,53	18,76	8,80

Subject to technical modifications and errors. Status of approval 05.2023

* Characteristic values for measurement according to EC 5, bulk density $\rho_k = 350 \text{ kg/m}^3$ (C24). Selected steel part thickness 15 mm

GOFIX[®] S+

Static values

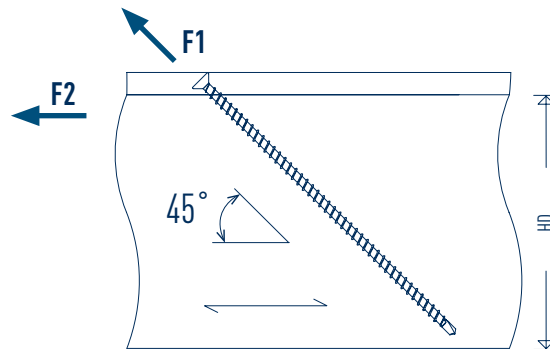

Art. No.	SIHGA [®] montagepack	PU	Dimension GoFix [®] S+	Wooden component HD	Characteristic values*	
					Tensile force F1 [kN]	Transverse force F2 [kN]
42406		75	8,0 x 95	70	6,11	4,32
42416		75	8,0 x 125	95	8,77	6,20
42426		75	8,0 x 155	115	11,44	8,09
42436		75	8,0 x 195	145	14,99	10,60
42446		75	8,0 x 220	165	17,21	12,17
42456		75	8,0 x 245	180	19,43	13,74
42466		75	8,0 x 270	200	21,65	15,31
42476		75	8,0 x 295	215	23,87	16,88
42486		75	8,0 x 330	240	25,00	17,68
42496		75	8,0 x 375	270	25,00	17,68
42506		75	8,0 x 400	290	25,00	17,68
42516		75	8,0 x 430	310	25,00	17,68
42526		75	8,0 x 480	345	25,00	17,68
42806		50	10,0 x 125	95	10,67	7,54
42816		50	10,0 x 155	115	13,91	9,84
42826		50	10,0 x 195	145	18,23	12,89
42836		50	10,0 x 220	165	20,93	14,80
42846		50	10,0 x 245	180	23,63	16,71
42856		50	10,0 x 270	200	26,33	18,62
42866		50	10,0 x 300	220	29,57	20,91
42876		50	10,0 x 330	240	32,81	23,20
42886		50	10,0 x 360	260	33,00	23,33
42896		50	10,0 x 400	290	33,00	23,33
42906		50	10,0 x 450	325	33,00	23,33
42916		50	10,0 x 500	360	33,00	23,33
42926		50	10,0 x 550	395	33,00	23,33
42936		50	10,0 x 600	430	33,00	23,33

Subject to technical modifications and errors. Status of approval 05.2023

* Characteristic values for measurement according to EC 5, bulk density $\rho_k = 350 \text{ kg/m}^3$ (C24). Selected steel part thickness 15 mm

ANGLE FITTING SCREW (WBS)

For quick and easy screwing in

The angle fitting screw (WBS) is made of **hardened carbon steel** and was specially designed for **connections between steel sheeting and wood**. The splitting effect in the wood is reduced by the geometry of the screw tip. The screw also features, among other things, the **smooth shank under the head**, which enables load transfer during shearing.

Advantages

- **Half-round head**
 - » Screw head rests on the material surface
 - » Minimisation of the risk of injury in case of contact
- **Below-head cylinder**
 - » For better transmission of transverse forces from the steel attachment to the screw body
- **Coarse thread**
 - » Allows faster screwing in
- **Screw tip with scraper groove**
 - » Ensures quick and easy screwing in



ETA-11/0425



SIHGA® montagepack		Dimension Angle fitting screw (WBS)			
Art. No.	PU	d1 x L	TX	DK	S
60826	250	5,0 x 50	20	7,2	9,0
60836	250	5,0 x 60	20	7,2	9,0
60846	250	5,0 x 70	20	7,2	9,0

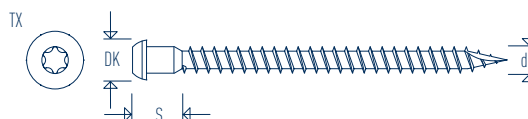

Angle fitting screw in Mass-X® Angle Z.

ANGLE FITTING SCREW (WBS)

Technical information Winding resistance

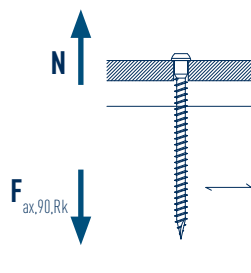

Steel-wood shearing

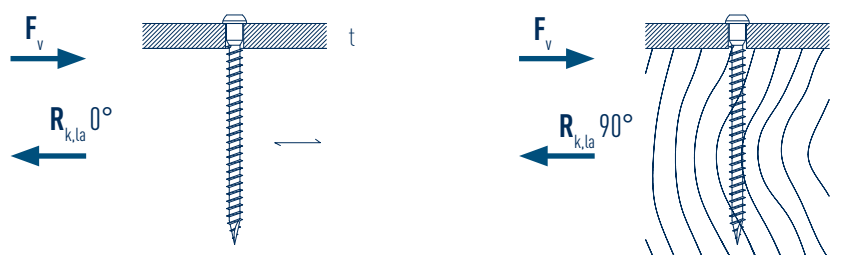

Dimension Angle fitting screw (WBS)	Extract resistance		Steel-wood shearing	
	$F_{ax,90,Rk}$	t [mm]	$R_{k,la} 0^\circ$ [kN]	$R_{k,la} 90^\circ$ [kN]
$d1 \times L$	$t \geq 9,0$ [mm]		$\alpha = 0^\circ$	$\alpha = 90^\circ$
5,0 x 50	2,48	1,5 - 4	2,36	1,97
5,0 x 60	3,09		2,51	2,12
5,0 x 70	3,69		2,67	2,27

Measurement according to ETA-11/0425. Bulk density $\rho_k = 350 \text{ kg/m}^3$. ³. All mechanical values given are to be considered depending on the assumptions made and represent design examples. All values are calculated minimum values and are subject to typesetting and printing errors.

a) The characteristic values of the load-bearing capacity R_k are not to be equated with the max. possible action (the max. force). Characteristic values of the load-bearing capacity R_k are to be reduced to design values R_d in relation to service class and class of load duration: $R_d = R_k \cdot k_{mod} / \gamma_M$. The design values of the load-bearing capacity R_d are to be compared with the design values of the actions E_d ($R_d \geq E_d$).

Example:

Characteristic value for permanent action (dead load) $G_k = 2,00 \text{ kN}$ and variable action (e.g. snow load) $Q_k = 3,00 \text{ kN}$. $k_{mod} = 0,9$. $\gamma_M = 1,3$.

→ Design value of the action $E_d = 2,00 \cdot 1,35 + 3,00 \cdot 1,5 = 7,20 \text{ kN}$.

Load-bearing capacity of the connection is considered to be verified if $R_d \geq E_d$. → $\min R_k = R_d \cdot \gamma_M / k_{mod}$

In other words, the characteristic minimum value of the load-bearing capacity is calculated as: $\min R_k = R_d \cdot \gamma_M / k_{mod} \rightarrow R_k = 7,20 \text{ kN} \cdot 1,3 / 0,9 = 10,40 \text{ kN}$ → Comparison with table values.

Caution: These are planning tools. Projects must be dimensioned exclusively by authorised persons.

Caution: Check the assumptions made. The specified values, type and number of connecting materials represent a pre-dimensioning. Projects must be dimensioned exclusively by authorised persons in accordance with the State Building Code. For definitive proof of stability, please contact a structural engineer qualified according to the State Building Code (LBauO).

GOFIX[®] ZSS

The screw for Mass-X[®] Pull Angle / Mass-X[®] Angle Q HH/HB and Mass-X[®] Pull HH / HB

The GoFix[®] ZSS can always be inserted into CLT without pre-drilling. The GoFix[®] ZSS is a wood construction screw with a special screw tip and milling ribs above the thread.

The cutting notch on the screw tip ensures quick gripping and less of a splitting effect when screwing in. The GoFix[®] ZSS also has a folded thread, which reduces the resistance to screwing in.

Advantages

- Faster and easier screwing in
- Less splitting effect
- National and international approvals
- Free from chromium (VI) oxide
- No hammering of the screws when screwing in



ETA-11/0425



SIHGA[®]
montagepack

Dimension
GoFix[®]ZSS

Art. No.	PU	d1 x L	TX	DK	S
60816	200	5,0 x 120	25	10,0	50,0

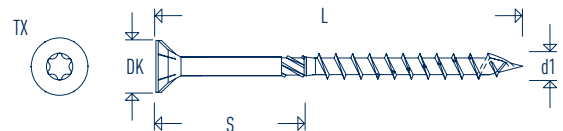

GOFIX[®] ZSS

Technical information

Extract resistance

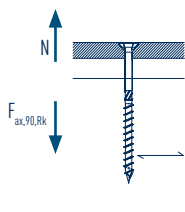

Head pull-through resistance

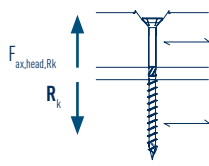

Wood-wood shear-off

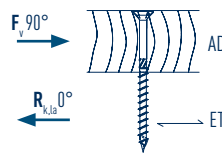
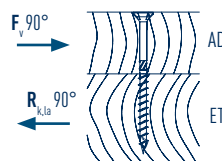
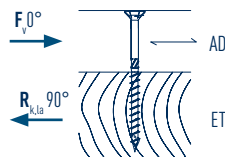
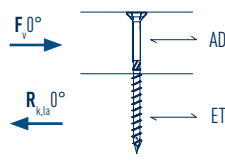

Steel-wood shear-off

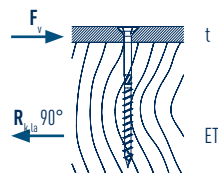
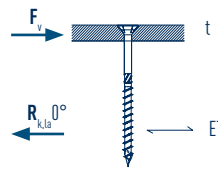

Dimension	Extract resistance	Head pull-through resistance	Wood-wood shear-off				Steel-wood shear-off		
GoFix [®] ZSS	$F_{ax,90,Rk}$ [kN]	$F_{ax,head,Rk}$ [kN]	$R_{k,la}$ [kN]		t [mm]	$R_{k,la}$ [kN]			
d1 x L			$\alpha_{AD} = 0^\circ$ $\alpha_{ET} = 0^\circ$	$\alpha_{AD} = 90^\circ$ $\alpha_{ET} = 90^\circ$	$\alpha_{AD} = 0^\circ$ $\alpha_{ET} = 90^\circ$	$\alpha_{AD} = 90^\circ$ $\alpha_{ET} = 0^\circ$	$\alpha_{ET} = 0^\circ$ $\alpha_{ET} = 90^\circ$		
5,0 x 120	4,24	1,20	1,48	1,04	1,19	1,14	2	2,73	2,11

Measurement according to ETA-11/0425. Bulk density $\rho_k = 350 \text{ kg/m}^3$. All mechanical values given are to be considered depending on the assumptions made and represent design examples. All values are calculated minimum values and are subject to typesetting and printing errors.

a) The characteristic values of the load-bearing capacity R_k are not to be equated with the max. possible action (the max. force). Characteristic values of the load-bearing capacity R_k are to be reduced to design values R_d in relation to service class and class of load duration: $R_d = R_k \cdot k_{mod} / \gamma_M$. The design values of the load-bearing capacity R_d are to be compared with the design values of the actions E_d ($R_d \geq E_d$).

Beispiel:

Characteristic value for permanent action (dead load) $G_k = 2,00 \text{ kN}$ and variable action (e.g. snow load) $Q_k = 3,00 \text{ kN}$. $k_{mod} = 0,9$. $\gamma_M = 1,3$.

→ Design value of the action $E_d = 2,00 \cdot 1,35 + 3,00 \cdot 1,5 = 7,20 \text{ kN}$.

Load-bearing capacity of the connection is considered to be verified if $R_d \geq E_d$. → $\min R_k = R_d \cdot \gamma_M / k_{mod}$

In other words, the characteristic minimum value of the load-bearing capacity is calculated as: $\min R_k = R_d \cdot \gamma_M / k_{mod} \rightarrow R_k = 7,20 \text{ kN} \cdot 1,3 / 0,9 = 10,40 \text{ kN}$ → Comparison with table values.

Caution: These are planning tools. Projects must be dimensioned exclusively by authorised persons.

Caution: Check the assumptions made. The specified values, type and number of connecting materials represent a pre-dimensioning. Projects must be dimensioned exclusively by authorised persons in accordance with the State Building Code. For definitive proof of stability, please contact a structural engineer qualified according to the State Building Code (LBauD).

ANKERNAGEL

with flat head



SIHGA [®] montagepack		Dimension Anchor nail	Material
Art. No.	PU	d1 x L	
60856	250	4,0 x 40	galvanised
60866	250	4,0 x 50	galvanised
60876	250	4,0 x 60	galvanised

To match:

Mass-X[®] Angle Q, Mass-X[®] Shear, Mass-X[®] Angle Q HB,
Mass-X[®] Angle Q HH, Mass-X[®] Pull HB/HH

MASS-X[®] CALM

The perfect solution for sound reduction

Advantages

- Sustainable, natural materials: cork and natural rubber
- High load capacity (0.1 N/mm² - 3 N/mm²)
- Not visible when laid
- Easy to process
- Water and gas-permeable to a limited extent depending on the structure

Material

The Mass-X[®] Calm is a compound of the components cork and natural rubber. This product is suitable for vibration damping applications where very high insulation values are required and used as non-visible insulators (pads/strips) with low resonance frequency, as well as a medium-low load.

Sound reduction

The Mass-X[®] Calm protective cork is able to achieve a sound reduction of up to 40 dB

Technical data

	Mass-X [®] Calm 1	Mass-X [®] Calm 2	Mass-X [®] Calm 3
	Load ranges [N/mm ²]		
Temperature range [°C]	10/+100	-10/+100	-10/+100
Density [kg/m ³]	700	1100	1125
Shore hardness [shore A]	35 - 50	45 - 60	60 - 80
Breaking strain [%]	> 200	> 300	> 100
Tensile strength [N/mm ²]	> 2,0	> 5,0	> 6,0
Compression 23°C / 70 h [%]	< 15	< 15	< 15
Static permanent load [N/mm ²]	0,1 - 0,39	0,4 - 1,4	1,5 - 3,1



Mass-X[®] Calm for separation and sound insulation of foundation and threshold timber



Mass-X[®] Calm 1

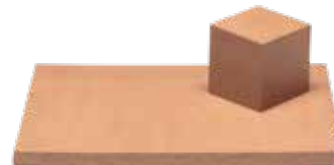

Mass-X[®] Calm 2



Mass-X[®] Calm 3

SIHGA [®] montagepack	Designation	Dimension Width x length	Material thickness
Art. No.	PU	Typ	[mm]
60886	15	Mass-X [®] Calm 1	100 x 1100
60896	15	Mass-X [®] Calm 2	100 x 1100
60906	15	Mass-X [®] Calm 3	100 x 1100

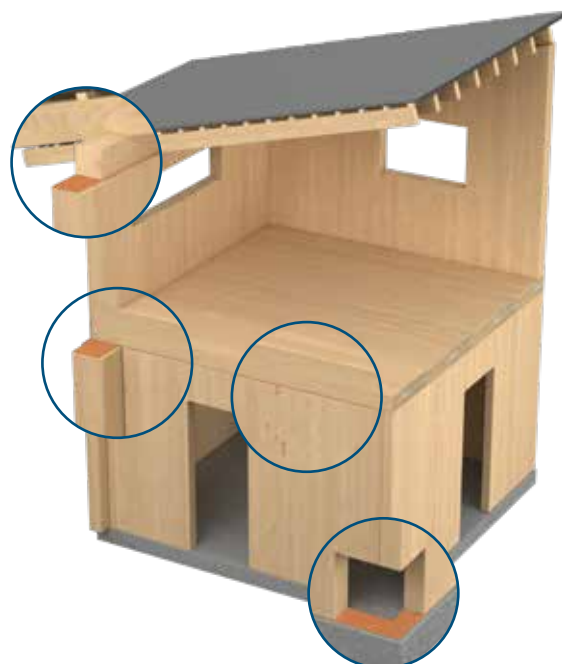

MASS-X[®] CALM

	6 mm				12 mm		
	Static permanent load	Natural frequency	Deflection	Modulus of elasticity at 10 Hz	Natural frequency	Deflection	Modulus of elasticity at 10 Hz
	[N/mm ²]	[Hz]	[mm]	[N/mm ²]	[Hz]	[mm]	[N/mm ²]
Mass-X[®] Calm 1	0,1	44	0,2	4,0	27	0,5	3,7
	0,2	33	0,5	4,5	19	1,3	4,0
	0,3	27	0,8	5,6	17	1,9	5,1
	0,4	27	1,1	6,9	17	2,6	6,5
Mass-X[®] Calm 2	0,5	50	0,2	11,5	31	0,4	10,5
	0,8	38	0,4	15,75	22	1,0	14,0
	1,1	31	0,7	19,5	20	1,6	18,0
	1,5	31	0,9	28,5	20	2,2	27,0
Mass-X[®] Calm 3	1,6	58	0,3	18,5	36	0,6	17,0
	2,4	44	0,6	24,5	25	1,3	22,0
	3,2	35	1,0	30,5	23	2,0	28,0
	4,0	35	1,5	43,0	23	2,7	41,0

Linear interpolation is permitted for intermediate values.

In the next step, we take a closer look at the noise frequency. To do this, we look at the following graphs and can see that the sound reduction in the low frequency range has worsened. Low frequencies (bass) can only be isolated by mass. The frequencies to be isolated for building acoustics start in the 80 Hz range, so this is negligible. If no interference frequencies are specified, 80 Hz can be assumed.

The sound reduction in dB can be determined in two ways:

Way 1:

Starting from an interference frequency of 80 Hz, a sound reduction of approx. 17 dB can be read from the following graph. These values are achieved under ideal conditions (optimum room temperature, room humidity, etc.).

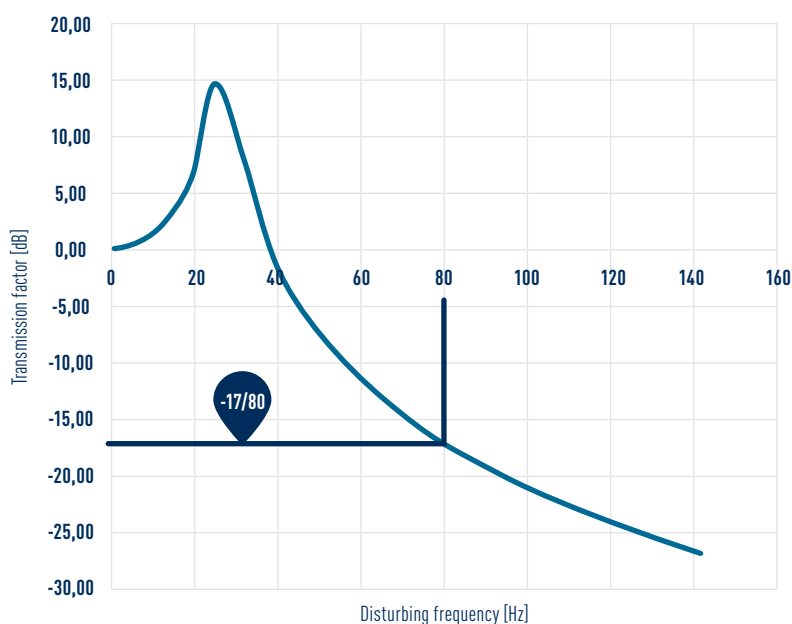

MASS-X[®] CALM

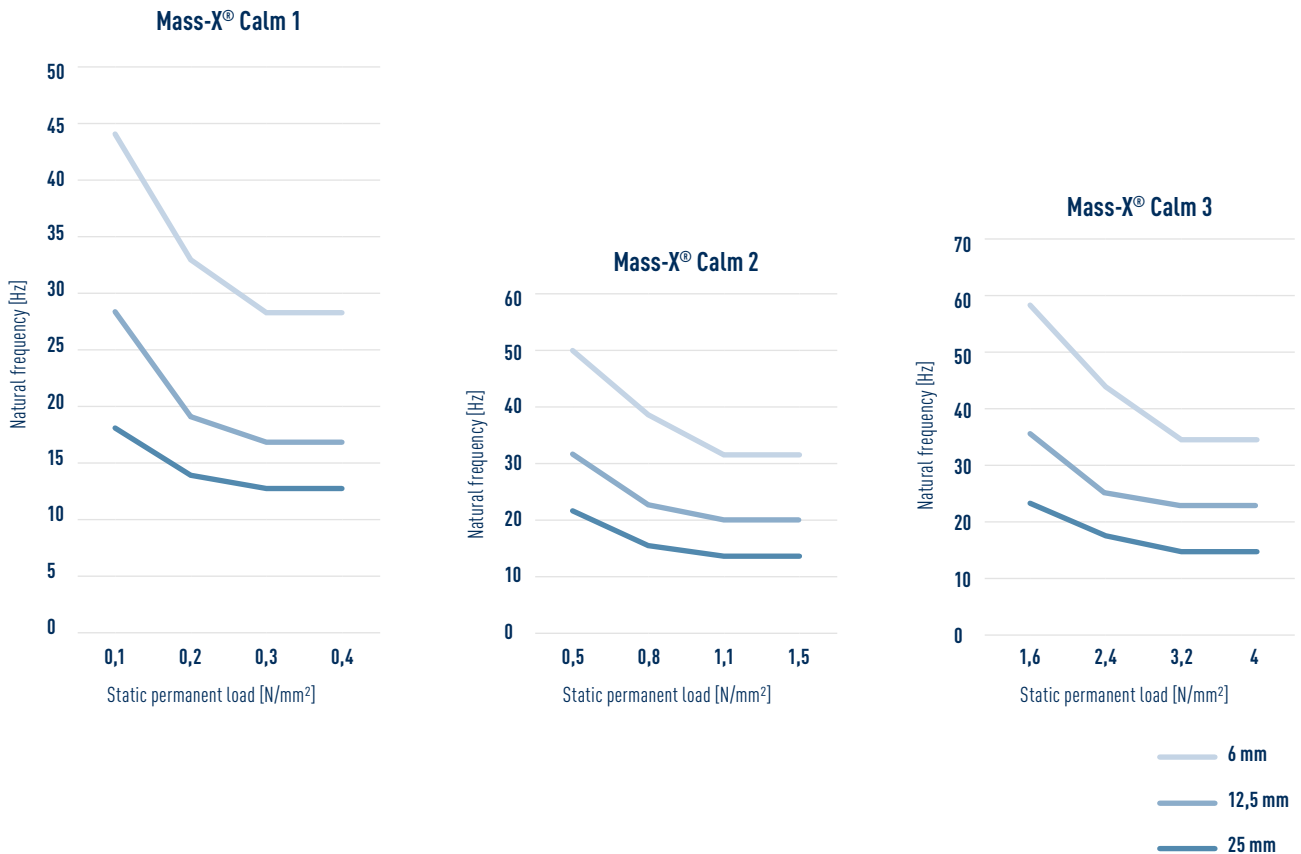

Way 2:

A sound attenuation factor can be calculated from the previously determined natural frequency (27 Hz) and the specified interference frequency (80 Hz).

Sound insulation factor $f/f_0 < \sqrt{2}$: Disturbing frequency / Natural frequency
 $\rightarrow 80 \text{ Hz} / 27 \text{ Hz} \approx 2,96 < \sqrt{2}$

*An essential criterion for efficient elastic mounting is the natural frequency f_0 of the vibration system. The lowest frequency f to be damped must be assumed and a tuning ratio f/f_0 of at least $\sqrt{2}$ (1,41) must be maintained. Only from this ratio onwards does structure-borne sound insulation increase with increasing excitation frequency.

Using the previously calculated factor, the sound reduction can then be read off. Under ideal conditions, this is 17 dB.

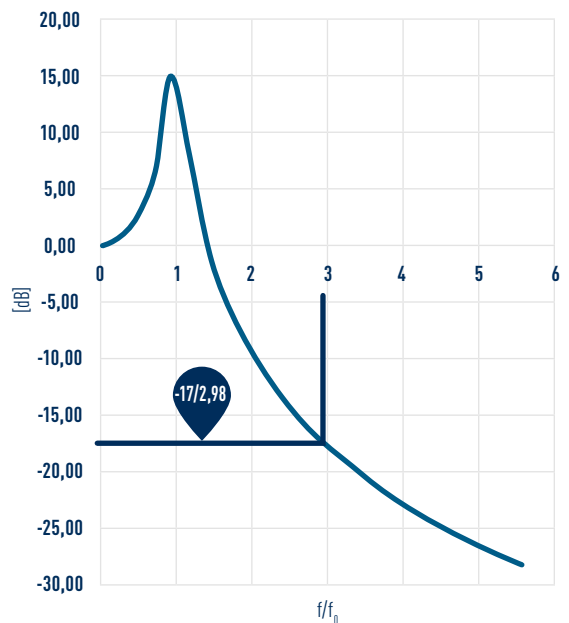

*Source: Deckenkonstruktion für den mehrgeschoßigen Holzbau – Schall- und Brandschutz | Detailkatalog | Band 20 der HFA-Schriftreihe, 5th improved edition, September 2016.

MASS-X[®] CALM

Last step

In the last step, the deflection of the Mass-X[®] Calm is determined. This step is especially important for the designers of the building. The deflection is also determined by the permanent load and there is a separate graph for each Mass-X[®] Calm. For the example calculation with Mass-X[®] Calm 1 and 0.3 N/mm², the following graph shows a deflection of 0.8 mm.

The graphs shown here will of course adjust according to the previously determined factors

For Mass-X[®] Calm 2 and Mass-X[®] Calm 3, the following graphs apply to the deflection:

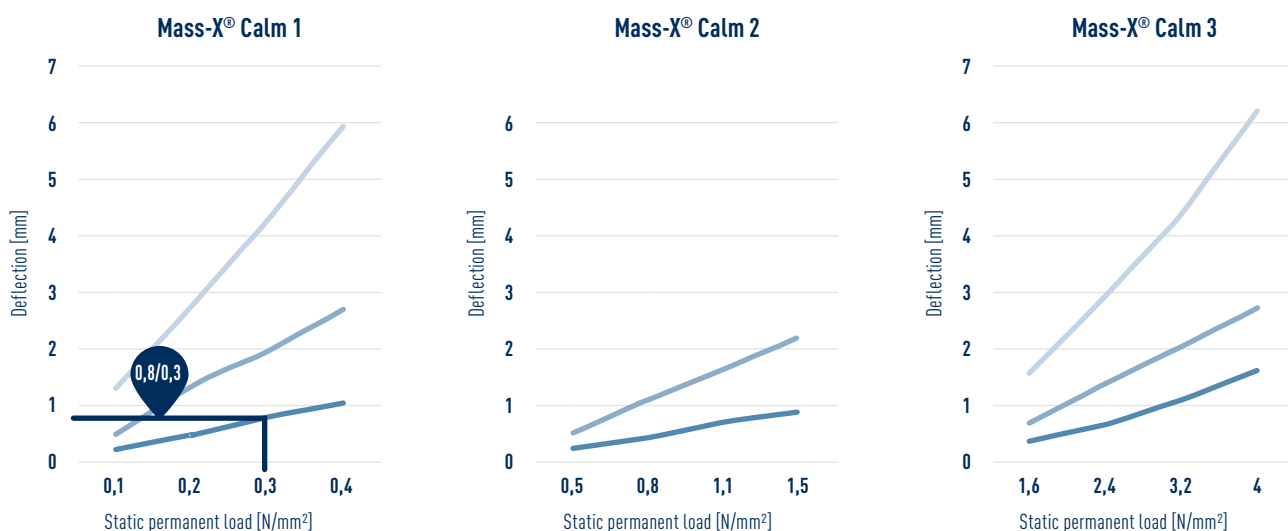

Caution: Check the assumptions made. The specified values, type and number of connecting materials represent a pre-dimensioning. Projects must be dimensioned exclusively by authorised persons in accordance with the State Building Code. For definitive proof of stability, please contact a structural engineer qualified according to the State Building Code (LBau0).

— 6 mm
— 12,5 mm
— 25 mm

Static permanent load	6 mm				12 mm		
	Natural frequency	Deflection	Modulus of elasticity at 10 Hz	Natural frequency	Deflection	Modulus of elasticity at 10 Hz	
	[Hz]	[mm]	[N/mm ²]	[Hz]	[mm]	[N/mm ²]	
0,1	44	0,2	4,0	27	0,5	3,7	
0,2	33	0,5	4,5	19	1,3	4,0	
0,3	27	0,8	5,6	17	1,9	5,1	
0,4	27	1,1	6,9	17	2,6	6,5	
0,5	50	0,2	11,5	31	0,4	10,5	
0,8	38	0,4	15,75	22	1,0	14,0	
1,1	31	0,7	19,5	20	1,6	18,0	
1,5	31	0,9	28,5	20	2,2	27,0	
1,6	58	0,3	18,5	36	0,6	17,0	
2,4	44	0,6	24,5	25	1,3	22,0	
3,2	35	1,0	30,5	23	2,0	28,0	
4,0	35	1,5	43,0	23	2,7	41,0	

MASS-X[®] DECOUPLING PROFILE

For sound insulation and material separation

Advantages

- Flexible in use
- Can be cut to size individually (roll material)
- Ageing resistant
- UV-stable, ozone-resistant
- Free from conflict materials

Properties

- Density approx. 1.4 g/cm³
- Operating temperature -30 °C to +90 °C
- Shore hardness 48 = 0.500 N/mm² = 0.05 kN/m²

Instructions for use

Cut the Mass-X[®] Decoupling profile to the desired length and place it in the desired position. Then mechanically fasten approx. every 40 - 60 cm, e.g. with a hammer tacker.



SIHGA [®] montagepack	PU	Dimension		Material thickness [mm]	Material
		Width [mm]	Length [m]		
60916	1	95	20	5	EPDM

Material properties

Property	Measuring method	Unit	Value
Hardness	DIN ISO 7619-1	Shore A	48
Density	DIN 53479	g/cm ³	1,23
Tear resistance	DIN 53504	MPa	8,5
Elongation at break	DIN 53504	%	510
Compression set	DIN ISO 815-1	%	≤ 40
Temperature resistance		°C	-30/100°C

Caution: Check the assumptions made. The specified values, type and number of connection materials represent a pre-dimensioning. Projects must be dimensioned exclusively by authorised persons in accordance with the State Building Code. For definitive proof of stability, please contact a structural engineer qualified according to the State Building Code (LBauO).



Mass-X[®] Decoupling profile for material separation and sound insulation



Mass-X[®] Decoupling profile under beams for sound insulation.

MASS-X[®] ANGLE DECOUPLING

Perfect complement to Mass-X[®] Angle Q HH/HB and Mass-X[®] Angle Z

The underlays are made from a combination of the components cork and natural rubber.

The product is suitable for vibration damping applications where very high insulation values are required. The Mass-X[®] Angle decouplers are used as non-visible isolators (pads/strips) with low resonance frequency, as well as a medium-low load.

Advantages

- Easy assembly thanks to underlays
- Sustainable material
- Not visible
- High load capacity
- REACH-compliant

Instructions for use

The Mass-X[®] Angle decouplers have cut-outs for the concrete screws for use in concrete. An increase of the separation layer to 12 mm is possible by double layering. When used in wood, the material can be screwed through. The application must be determined in advance by a structural engineer. No statement can be made about sound reduction, as this depends on the design.



SIHGA [®] montagepack		Dimension	Suitable for	
Art. No.	PU	[mm]	Art.-No.	Designation
60936	5	230 x 70 x 6	60746	Mass-X [®] Angle Q HH
60946	5	230 x 80 x 6	60736	Mass-X [®] Angle Z
60956	5	230 x 100 x 6	60756	Mass-X [®] Angle Q HB
60726	5	230 x 120 x 6	60706	Mass-X [®] Angle Q



Mass-X[®] Angle Q for fixing a wall to the concrete foundation.

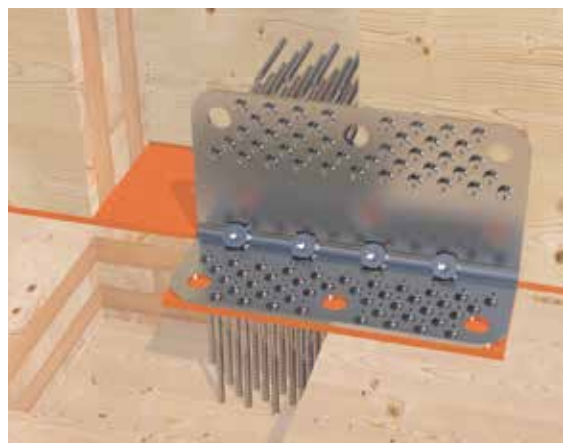

Mass-X[®] Angle Z for fixing a wall to the wooden floor of the upper storey.

Edition: 06.2023/2.0 | Art.No.: 20226
www.sihga.com

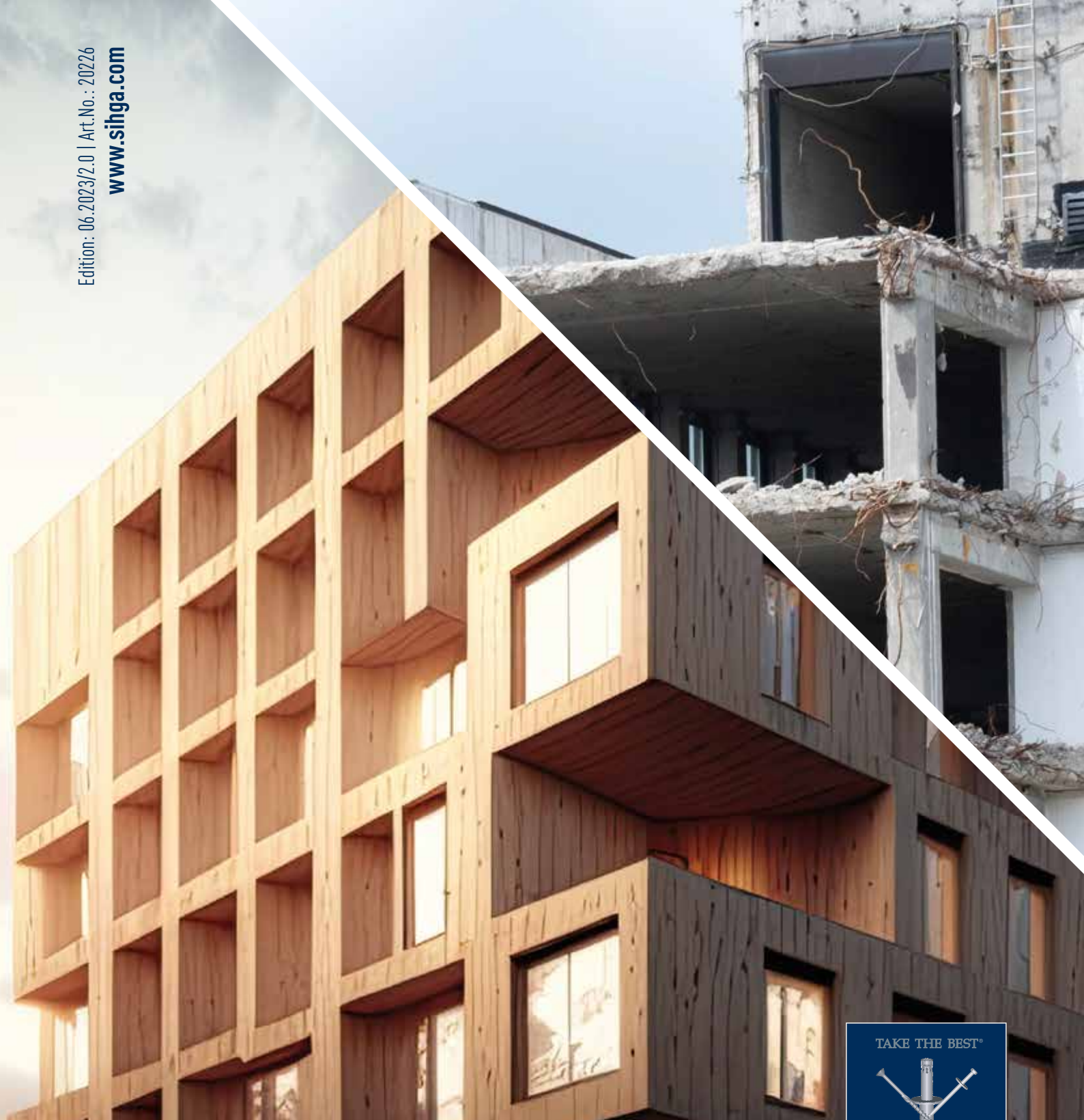

TAKE THE BEST



Leitbetrieb Österreich Leitbetrieb Deutschland



SIHGA® GmbH | Austria

Gewerbepark Kleinreith 4 | 4694 Ohlsdorf bei Gmunden | Austria | Tel +43 7612 74370 0 | info@sihga.com

Opening hours: Mon - Thu 07:30 to 12:00 and 12:30 to 17:00 Uhr | FR 07:30 to 12:00 and 12:30 to 15:00 Uhr

